

*Instant Help for  
C# 4.0 Programmers*



*Pocket Reference*

**O'REILLY**<sup>®</sup>

*Joseph Albarari  
& Ben Albarari*

**O'REILLY®**

## C# 4.0 Pocket Reference

When you're programming C# 4.0 and need a little help, this tightly focused and practical book tells you exactly what you need to know—without long introductions or bloated examples. It's ideal as a succinct quick reference or as a guide to get you rapidly up to speed if you already know Java, C++, or an earlier version of C#.

Written by the authors of the acclaimed *C# 4.0 in a Nutshell* (O'Reilly), this book covers the entire C# 4.0 language—without skimming on the details—including:

- Features new to C# 4.0, such as dynamic binding, optional and named parameters, and type parameter variance
- All of C#'s fundamentals
- Advanced topics, including operator overloading, custom conversions, type constraints, covariance and contravariance, lambda expressions and closures, iterators, nullable types, and operator lifting
- LINQ, starting with sequences, lazy execution, and standard query operators; finishing with a complete reference to query expressions
- Unsafe code and pointers, custom attributes, preprocessor directives, and XML documentation

Joe Albahari is the author of LINQPad and other C# tools. He has been developing large-scale enterprise applications for more than 17 years.

Ben Albahari, a former program manager at Microsoft, is the founder of TakeOnIt, a website for comparing the opinions of experts, leaders, and organizations on controversial topics.

**oreilly.com**

US \$14.99

CAN \$18.99

ISBN: 978-1-449-39401-1

**Safari<sup>®</sup>**  
Books Online

**Free online edition**  
for 45 days with  
purchase of this book.  
Details on last page.

---

**C# 4.0**  
*Pocket Reference*



THIRD EDITION

---

**C# 4.0**  
*Pocket Reference*

*Joseph Albahari and Ben Albahari*

**O'REILLY®**

Beijing • Cambridge • Farnham • Köln • Sebastopol • Taipei • Tokyo

**C# 4.0 Pocket Reference, Third Edition**

by Joseph Albahari and Ben Albahari

Copyright © 2010 Joseph Albahari and Ben Albahari. All rights reserved.  
Printed in Canada.

Published by O'Reilly Media, Inc., 1005 Gravenstein Highway North, Sebastopol, CA 95472.

O'Reilly books may be purchased for educational, business, or sales promotional use. Online editions are also available for most titles (<http://my.safaribooksonline.com>). For more information, contact our corporate/institutional sales department: (800) 998-9938 or [corporate@oreilly.com](mailto:corporate@oreilly.com).

**Editor:** Mike Hendrickson  
**Production Editor:** Kristen Borg  
**Proofreader:** Kiel Van Horn  
**Indexer:** Angela Howard  
**Cover Designer:** Karen Montgomery  
**Interior Designer:** David Futato  
**Illustrator:** Robert Romano

**Printing History:**

November 2002:	First Edition.
February 2008:	Second Edition.
August 2010:	Third Edition.

Nutshell Handbook, the Nutshell Handbook logo, and the O'Reilly logo are registered trademarks of O'Reilly Media, Inc. *C# 4.0 Pocket Reference*, the image of an African crowned crane, and related trade dress are trademarks of O'Reilly Media, Inc.

Many of the designations used by manufacturers and sellers to distinguish their products are claimed as trademarks. Where those designations appear in this book, and O'Reilly Media, Inc., was aware of a trademark claim, the designations have been printed in caps or initial caps.

While every precaution has been taken in the preparation of this book, the publisher and authors assume no responsibility for errors or omissions, or for damages resulting from the use of the information contained herein.

ISBN: 978-1-449-39401-1

[TM]

1280502296

---

# Contents

<b>C# 4.0 Pocket Reference</b>	<b>1</b>
Using Code Examples	2
How to Contact Us	2
Safari® Books Online	3
A First C# Program	3
Compilation	6
Syntax	7
Identifiers and Keywords	7
Literals, Punctuators, and Operators	9
Comments	10
Type Basics	10
Predefined Type Examples	10
Custom Type Examples	11
Conversions	14
Value Types Versus Reference Types	15
Predefined Type Taxonomy	18
Numeric Types	19
Numeric Literals	20
Numeric Conversions	21
Arithmetic Operators	22
Increment and Decrement Operators	22
Specialized Integral Operations	22

8- and 16-Bit Integrals	24
Special Float and Double Values	24
double Versus decimal	25
Real Number Rounding Errors	25
Boolean Type and Operators	26
Equality and Comparison Operators	26
Conditional Operators	27
Strings and Characters	28
String Type	29
Arrays	31
Default Element Initialization	32
Multidimensional Arrays	33
Simplified Array Initialization Expressions	34
Variables and Parameters	35
The Stack and the Heap	35
Definite Assignment	36
Default Values	37
Parameters	37
var—Implicitly Typed Local Variables	42
Expressions and Operators	43
Assignment Expressions	43
Operator Precedence and Associativity	44
Operator Table	45
Statements	48
Declaration Statements	48
Expression Statements	48
Selection Statements	49
Iteration Statements	52
Jump Statements	54
Namespaces	55
The using Directive	57
Rules Within a Namespace	57



Aliasing Types and Namespaces	59
Classes	59
Fields	59
Methods	60
Instance Constructors	61
Object Initializers	62
The this Reference	63
Properties	63
Indexers	65
Constants	66
Static Constructors	67
Static Classes	68
Finalizers	68
Partial Types and Methods	68
Inheritance	70
Polymorphism	71
Casting and Reference Conversions	71
Virtual Function Members	73
Abstract Classes and Abstract Members	74
Hiding Inherited Members	74
Sealing Functions and Classes	75
The base Keyword	75
Constructors and Inheritance	76
Overloading and Resolution	77
The object Type	78
Boxing and Unboxing	79
Static and Runtime Type Checking	80
The GetType Method and typeof Operator	80
Object Member Listing	81
Equals, ReferenceEquals, and GetHashCode	81
The ToString Method	82
Structs	82

Struct Construction Semantics	83
Access Modifiers	83
Friend Assemblies	84
Accessibility Capping	84
Interfaces	85
Extending an Interface	86
Explicit Interface Implementation	86
Implementing Interface Members Virtually	87
Reimplementing an Interface in a Subclass	87
Enums	88
Enum Conversions	89
Flags Enums	90
Enum Operators	91
Nested Types	91
Generics	92
Generic Types	92
Generic Methods	93
Declaring Type Parameters	94
typeof and Unbound Generic Types	95
The default Generic Value	95
Generic Constraints	95
Subclassing Generic Types	97
Self-Referencing Generic Declarations	97
Static Data	97
Covariance (C# 4.0)	98
Contravariance (C# 4.0)	99
Delegates	100
Writing Plug-in Methods with Delegates	101
Multicast Delegates	102
Instance Versus Static Method Targets	103
Generic Delegate Types	103
The Func and Action Delegates	103

Delegate Compatibility	104
Events	107
Standard Event Pattern	108
Event Accessors	111
Lambda Expressions	112
Capturing Outer Variables	114
Anonymous Methods	116
try Statements and Exceptions	117
The catch Clause	119
The finally Block	120
Throwing Exceptions	122
Key Properties of System.Exception	123
Common Exception Types	123
Enumeration and Iterators	125
Enumeration	125
Collection Initializers	126
Iterators	126
Iterator Semantics	127
Composing Sequences	129
Nullable Types	130
Nullable Basics	131
Operator Lifting	132
bool? with & and   Operators	134
Null Coalescing Operator	134
Operator Overloading	135
Operator Functions	135
Overloading Equality and Comparison Operators	136
Custom Implicit and Explicit Conversions	137
Extension Methods	138
Extension Method Chaining	139
Ambiguity and Resolution	139
Anonymous Types	140

LINQ	140
LINQ Fundamentals	141
Deferred Execution	145
Standard Query Operators	147
Chaining Query Operators	151
Query Expressions	152
The let Keyword	155
Query Continuations	156
Multiple Generators	157
Joining	158
Ordering	161
Grouping	162
OfType and Cast	164
Dynamic Binding (C# 4.0)	165
Static Binding Versus Dynamic Binding	165
Custom Binding	167
Language Binding	168
RuntimeBinderException	169
Runtime Representation of dynamic	169
Dynamic Conversions	170
var Versus dynamic	170
Dynamic Expressions	170
Dynamic Member Overload Resolution	171
Uncallable Functions	172
Attributes	173
Attribute Classes	174
Named and Positional Attribute Parameters	174
Attribute Targets	175
Specifying Multiple Attributes	175
Writing Custom Attributes	175
Retrieving Attributes at Runtime	176
Unsafe Code and Pointers	177

Pointer Basics	177
Unsafe Code	178
The fixed Statement	178
The Pointer-to-Member Operator	179
Arrays	180
void*	181
Pointers to Unmanaged Code	181
Preprocessor Directives	182
Pragma Warning	183
XML Documentation	184
Standard XML Documentation Tags	185
<b>Index</b>	<b>189</b>

Download from Library of Wow! eBook  
<[www.wowebook.com](http://www.wowebook.com)>



---

# C# 4.0 Pocket Reference

C# is a general-purpose, type-safe, object-oriented programming language whose goal is programmer productivity. To this end, the language balances simplicity, expressiveness, and performance. The C# language is platform-neutral, but it was written to work well with the Microsoft *.NET Framework*. C# 4.0 targets .NET Framework 4.0.

---

## NOTE

The programs and code snippets in this book mirror those in Chapters 2–4 of *C# 4.0 in a Nutshell* (Joseph and Ben Albahari, O'Reilly) and are all available as interactive samples in LINQPad. Working through these samples in conjunction with the book accelerates learning, in that you can edit the samples and instantly see the results without needing to set up projects and solutions in Visual Studio.

To download the samples, click the *Samples* tab in LINQPad and click “Download more samples.” LINQPad is free—go to <http://www.linqpad.net>.

---

## Using Code Examples

This book is here to help you get your job done. In general, you may use the code in this book in your programs and documentation. You do not need to contact us for permission unless you're reproducing a significant portion of the code. For example, writing a program that uses several chunks of code from this book does not require permission. Selling or distributing a CD-ROM of examples from O'Reilly books does require permission. Answering a question by citing this book and quoting example code does not require permission. Incorporating a significant amount of example code from this book into your product's documentation does require permission.

We appreciate, but do not require, attribution. An attribution usually includes the title, author, publisher, and ISBN. For example: "*C# 4.0 Pocket Reference*, Third Edition, by Joseph Albahari and Ben Albahari. Copyright 2010 Joseph Albahari and Ben Albahari, 978-1-449-39401-1."

If you feel that your use of code examples falls outside of fair use or the permission given here, feel free to contact us at [permissions@oreilly.com](mailto:permissions@oreilly.com).

## How to Contact Us

Please address comments and questions concerning this book to the publisher:

O'Reilly Media, Inc.  
1005 Gravenstein Highway North  
Sebastopol, CA 95472  
800-998-9938 (in the United States or Canada)  
707-829-0515 (international or local)  
707-829-0104 (fax)

We have a web page for this book, where we list errata, examples, and additional information. You can access this page at:

<http://oreilly.com/catalog/0636920013365/>



To comment or ask technical questions about this book, send email to:

[bookquestions@oreilly.com](mailto:bookquestions@oreilly.com)

For more information about our books, conferences, Resource Centers, and the O'Reilly Network, see our website at:

<http://oreilly.com>

## Safari® Books Online



Safari Books Online is an on-demand digital library that lets you easily search over 7,500 technology and creative reference books and videos to find the answers you need quickly.

With a subscription, you can read any page and watch any video from our library online. Read books on your cell phone and mobile devices. Access new titles before they are available for print, and get exclusive access to manuscripts in development and post feedback for the authors. Copy and paste code samples, organize your favorites, download chapters, bookmark key sections, create notes, print out pages, and benefit from tons of other time-saving features.

O'Reilly Media has uploaded this book to the Safari Books Online service. To have full digital access to this book and others on similar topics from O'Reilly and other publishers, sign up for free at <http://my.safaribooksonline.com>.

## A First C# Program

Here is a program that multiplies 12 by 30, and prints the result, 360, to the screen. The double forward slashes indicate that the remainder of a line is a *comment*:

```
using System;                // Importing namespace
```

```

class Test                // Class declaration
{
    static void Main()    // Method declaration
    {
        int x = 12 * 30;  // Statement 1
        Console.WriteLine (x); // Statement 2
    }                    // End of method
}                        // End of class

```

At the heart of this program lies two *statements*. Statements in C# execute sequentially. Each statement is terminated by a semicolon. The first statement computes the *expression* `12 * 30` and stores the result in a *local variable*, named `x`, which is an integer type. The second statement calls the `Console` class's `WriteLine` *method*, to print the variable `x` to a text window on the screen.

A *method* performs an action in a series of statements, called a *statement block*—a pair of braces containing zero or more statements. We defined a single method named `Main`.

Writing higher-level functions that call upon lower-level functions simplifies a program. We can *refactor* our program with a reusable method that multiplies an integer by 12, as follows:

```

using System;

class Test
{
    static void Main()
    {
        Console.WriteLine (FeetToInches (30)); // 360
        Console.WriteLine (FeetToInches (100)); // 1200
    }

    static int FeetToInches (int feet)
    {
        int inches = feet * 12;
        return inches;
    }
}

```

A method can receive *input* data from the caller by specifying *parameters* and *output* data back to the caller by specifying a *return type*. We defined a method called `FeetToInches` that has

a parameter for inputting feet, and a return type for outputting inches, both of type `int` (integer).

The *literals* `30` and `100` are the *arguments* passed to the `FeetToInches` method. The `Main` method in our example has empty parentheses because it has no parameters, and is `void` because it doesn't return any value to its caller. C# recognizes a method called `Main` as signaling the default entry point of execution. The `Main` method may optionally return an integer (rather than `void`) in order to return a value to the execution environment. The `Main` method can also optionally accept an array of strings as a parameter (that will be populated with any arguments passed to the executable). For example:

```
static int Main (string[] args) {...}
```

---

#### NOTE

An array (such as `string[]`) represents a fixed number of elements of a particular type (see the section “[Arrays](#)” on page 31).

---

Methods are one of several kinds of functions in C#. Another kind of function we used was the *\* operator*, to perform multiplication. There are also *constructors*, *properties*, *events*, *indexers*, and *finalizers*.

In our example, the two methods are grouped into a class. A *class* groups function members and data members to form an object-oriented building block. The `Console` class groups members that handle command-line input/output functionality, such as the `WriteLine` method. Our `Test` class groups two methods—the `Main` method and the `FeetToInches` method. A class is a kind of *type*, which we will examine in “[Type Basics](#)” on page 10.

At the outermost level of a program, types are organized into *namespaces*. The `using` directive was used to make the `System` namespace available to our application, to use the `Console`

class. We could define all our classes within the `TestPrograms` namespace, as follows:

```
using System;

namespace TestPrograms
{
    class Test {...}
    class Test2 {...}
}
```

The .NET Framework is organized into nested namespaces. For example, this is the namespace that contains types for handling text:

```
using System.Text;
```

The `using` directive is there for convenience; you can also refer to a type by its fully qualified name, which is the type name prefixed with its namespace, such as `System.Text.StringBuilder`.

## Compilation

The C# compiler compiles source code, specified as a set of files with the `.cs` extension, into an *assembly*. An assembly is the unit of packaging and deployment in .NET. An assembly can be either an *application* or a *library*. A normal console or Windows application has a `Main` method and is an `.exe` file. A library is a `.dll` and is equivalent to an `.exe` without an entry point. Its purpose is to be called upon (*referenced*) by an application or by other libraries. The .NET Framework is a set of libraries.

The name of the C# compiler is `csc.exe`. You can either use an IDE such as Visual Studio to compile, or call `csc` manually from the command line. To compile manually, first save a program to a file such as `MyFirstProgram.cs`, and then go to the command line and invoke `csc` (located under `%SystemRoot%\Microsoft.NET\Framework\<framework-version>`, where `%SystemRoot%` is your Windows directory) as follows:

```
csc MyFirstProgram.cs
```

This produces an application named *MyFirstProgram.exe*.

To produce a library (.dll), do the following:

```
csc /target:library MyFirstProgram.cs
```

## Syntax

C# syntax is based on C and C++ syntax. In this section, we will describe C#'s elements of syntax, using the following program:

```
using System;

class Test
{
    static void Main()
    {
        int x = 12 * 30;
        Console.WriteLine (x);
    }
}
```

## Identifiers and Keywords

*Identifiers* are names that programmers choose for their classes, methods, variables, and so on. These are the identifiers in our example program, in the order they appear:

```
System Test Main x Console WriteLine
```

An identifier must be a whole word, essentially made up of Unicode characters starting with a letter or underscore. C# identifiers are case-sensitive. By convention, parameters, local variables, and private fields should be in camel case (e.g., *myVariable*), and all other identifiers should be in Pascal case (e.g., *MyMethod*).

*Keywords* are names reserved by the compiler that you can't use as identifiers. These are the keywords in our example program:

```
using class static void int
```

Here is the full list of C# keywords:

abstract	enum	long	stackalloc
as	event	namespace	static
base	explicit	new	string
bool	extern	null	struct
break	false	object	switch
byte	finally	operator	this
case	fixed	out	throw
catch	float	override	true
char	for	params	try
checked	foreach	private	typeof
class	goto	protected	uint
const	if	public	ulong
continue	implicit	readonly	unchecked
decimal	in	ref	unsafe
default	int	return	ushort
delegate	interface	sbyte	using
do	internal	sealed	virtual
double	is	short	void
else	lock	sizeof	while

## Avoiding conflicts

If you really want to use an identifier that clashes with a keyword, you can do so by qualifying it with the @ prefix. For instance:

```
class class {...} // Illegal
class @class {...} // Legal
```

The @ symbol doesn't form part of the identifier itself. So @myVariable is the same as myVariable.

## Contextual keywords

Some keywords are *contextual*, meaning they can also be used as identifiers—without an @ symbol. These are:

add	from	join	select
ascending	get	let	set
by	global	on	value
descending	group	orderby	var
dynamic	in	partial	where
equals	into	remove	yield

With contextual keywords, ambiguity cannot arise within the context in which they are used.

## Literals, Punctuators, and Operators

*Literals* are primitive pieces of data statically embedded into the program. The literals in our example program are 12 and 30. *Punctuators* help demarcate the structure of the program. The punctuators in our program are, ;, {, and }.

The semicolon terminates a statement. Statements can wrap multiple lines:

```
Console.WriteLine
    (1 + 2 + 3 + 4 + 5 + 6 + 7 + 8 + 9 + 10);
```

The braces group multiple statements into a statement block.

An *operator* transforms and combines expressions. Most operators in C# are denoted with a symbol, such as the multiplication operator, \*. The operators in our program are:

```
. () * =
```

The period denotes a member of something (or a decimal point with numeric literals). The parentheses are used when declaring or calling a method; empty parentheses are used when the method accepts no arguments. The equals sign is used for

*assignment* (the double equals signs, `==`, are used for equality comparison).

## Comments

C# offers two different styles of source-code documentation: *single-line comments* and *multiline comments*. A single-line comment begins with a double forward slash and continues until the end of the line. For example:

```
int x = 3; // Comment about assigning 3 to x
```

A multiline comment begins with `/*` and ends with `*/`. For example:

```
int x = 3; /* This is a comment that
           spans two lines */
```

Comments may embed XML documentation tags (see [“XML Documentation” on page 184](#)).

## Type Basics

A *type* defines the blueprint for a value. A *value* is a storage location denoted by a *variable* (if it can change) or a *constant* (if it cannot). We created a local variable named `x` in our first program.

All values in C# are an *instance* of a specific type. The meaning of a value, and the set of possible values a variable can have, is determined by its type. The type of `x` in our example program is `int`.

## Predefined Type Examples

Predefined types (also called built-in types) are types that are specially supported by the compiler. The `int` type is a predefined type for representing the set of integers that fit into 32 bits of memory, from  $-2^{31}$  to  $2^{31}-1$ . We can perform functions such as arithmetic with instances of the `int` type as follows:



```
int x = 12 * 30;
```

Another predefined C# type is `string`. The `string` type represents a sequence of characters, such as “.NET” or “<http://oreilly.com>”. We can work with strings by calling functions on them as follows:

```
string message = "Hello world";
string upperMessage = message.ToUpper();
Console.WriteLine (upperMessage);    // HELLO WORLD

int x = 2007;
message = message + x.ToString();
Console.WriteLine (message);        // Hello world2007
```

The predefined `bool` type has exactly two possible values: `true` and `false`. The `bool` type is commonly used to conditionally branch execution flow with an `if` statement. For example:

```
bool simpleVar = false;
if (simpleVar)
    Console.WriteLine ("This will not print");

int x = 5000;
bool lessThanAMile = x < 5280;
if (lessThanAMile)
    Console.WriteLine ("This will print");
```

---

#### NOTE

The `System` namespace in the .NET Framework contains many important types that are not predefined by C# (e.g., `DateTime`).

---

## Custom Type Examples

Just as we can build complex functions from simple functions, we can build complex types from primitive types. In this example, we will define a custom type named `UnitConverter`—a class that serves as a blueprint for unit conversions:

```
using System;
```

```

public class UnitConverter
{
    int ratio; // Field

    public UnitConverter (int unitRatio) // Constructor
    {
        ratio = unitRatio;
    }

    public int Convert (int unit) // Method
    {
        return unit * ratio;
    }
}

class Test
{
    static void Main()
    {
        UnitConverter feetToInches = new UnitConverter(12);
        UnitConverter milesToFeet = new UnitConverter(5280);

        Console.Write (feetToInches.Convert(30)); // 360
        Console.Write (feetToInches.Convert(100)); // 1200
        Console.Write (feetToInches.Convert
            (milesToFeet.Convert(1))); // 63360
    }
}

```

## Members of a type

A type contains *data members* and *function members*. The data member of `UnitConverter` is the *field* called `ratio`. The function members of `UnitConverter` are the `Convert` method and the `UnitConverter`'s *constructor*.

## Symmetry of predefined types and custom types

A beautiful aspect of C# is that predefined types and custom types have few differences. The predefined `int` type serves as a blueprint for integers. It holds data—32 bits—and provides function members that use that data, such as `ToString`. Similarly, our custom `UnitConverter` type acts as a blueprint for unit

conversions. It holds data—the ratio—and provides function members to use that data.

## Constructors and instantiation

Data is created by *instantiating* a type. Predefined types can be instantiated simply by using a literal. For example, the following line instantiates two integers (12 and 30), which are used to compute a third instance, `x`:

```
int x = 12 * 30;
```

The `new` operator is needed to create a new instance of a custom type. We started our `Main` method by creating two instances of the `UnitConverter` type. Immediately after the `new` operator instantiates an object, the object's *constructor* is called to perform initialization. A constructor is defined like a method, except that the method name and return type are reduced to the name of the enclosing type:

```
public UnitConverter (int unitRatio) // Constructor
{
    ratio = unitRatio;
}
```

## Instance versus static members

The data members and function members that operate on the *instance* of the type are called instance members. The `UnitConverter`'s `Convert` method and the `int`'s `ToString` method are examples of instance members. By default, members are instance members.

Data members and function members that don't operate on the instance of the type, but rather on the type itself, must be marked as `static`. The `Test.Main` and `Console.WriteLine` methods are static methods. The `Console` class is actually a *static class*, which means *all* its members are static. You never actually create instances of a `Console`—one console is shared across the whole application.

To contrast instance versus static members, the instance field `Name` pertains to an instance of a particular `Panda`, whereas `Population` pertains to the set of all `Panda` instances:

```
public class Panda
{
    public string Name;           // Instance field
    public static int Population; // Static field

    public Panda (string n)      // Constructor
    {
        Name = n;                // Assign instance field
        Population = Population+1; // Increment static field
    }
}
```

The following code creates two instances of the `Panda`, prints their names, and then prints the total population:

```
Panda p1 = new Panda ("Pan Dee");
Panda p2 = new Panda ("Pan Dah");

Console.WriteLine (p1.Name);    // Pan Dee
Console.WriteLine (p2.Name);    // Pan Dah

Console.WriteLine (Panda.Population); // 2
```

## The public keyword

The `public` keyword exposes members to other classes. In this example, if the `Name` field in `Panda` was not `public`, the `Test` class could not access it. Marking a member `public` is how a type communicates: “Here is what I want other types to see—everything else is my own private implementation details.” In object-oriented terms, we say that the public members *encapsulate* the private members of the class.

## Conversions

`C#` can convert between instances of compatible types. A conversion always creates a new value from an existing one. Conversions can be either *implicit* or *explicit*: implicit conversions happen automatically, whereas explicit conversions require a *cast*. In the following example, we *implicitly* convert an

`int` to a `long` type (which has twice the bitwise capacity of an `int`) and *explicitly* cast an `int` to a `short` type (which has half the bitwise capacity of an `int`):

```
int x = 12345;           // int is a 32-bit integer
long y = x;             // Implicit conversion to 64-bit int
short z = (short)x;    // Explicit conversion to 16-bit int
```

In general, implicit conversions are allowed when the compiler can guarantee they will always succeed without loss of information. Otherwise, you must perform an explicit cast to convert between compatible types.

## Value Types Versus Reference Types

C# types can be divided into *value types* and *reference types*.

*Value types* comprise most built-in types (specifically, all numeric types, the `char` type, and the `bool` type) as well as custom `struct` and `enum` types. *Reference types* comprise all class, array, delegate, and interface types.

The fundamental difference between value types and reference types is how they are handled in memory.

### Value types

The content of a *value type* variable or constant is simply a value. For example, the content of the built-in value type, `int`, is 32 bits of data.

You can define a custom value type with the `struct` keyword (see [Figure 1](#)):

```
public struct Point { public int X, Y; }
```

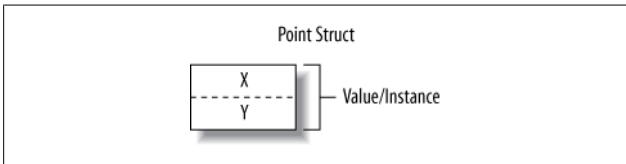

Figure 1. A value-type instance in memory

The assignment of a value-type instance always *copies* the instance. For example:

```
Point p1 = new Point();
p1.X = 7;

Point p2 = p1;           // Assignment causes copy

Console.WriteLine (p1.X); // 7
Console.WriteLine (p2.X); // 7

p1.X = 9;                // Change p1.X
Console.WriteLine (p1.X); // 9
Console.WriteLine (p2.X); // 7
```

Figure 2 shows that `p1` and `p2` have independent storage.

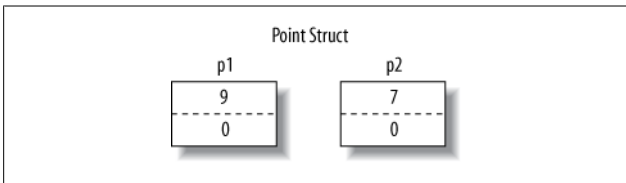

Figure 2. Assignment copies a value-type instance

## Reference types

A reference type is more complex than a value type, having two parts: an *object* and the *reference* to that object. The content of a reference-type variable or constant is a reference to an object that contains the value. Here is the `Point` type from our previous example rewritten as a class (see Figure 3):

```
public class Point { public int X, Y; }
```

Assigning a reference-type variable copies the reference, not the object instance. This allows multiple variables to refer to the same object—something not ordinarily possible with value types. If we repeat the previous example, but with `Point` now a class, an operation via `p1` affects `p2`:

```
Point p1 = new Point();
p1.X = 7;
```

```

Point p2 = p1;           // Copies p1 reference

Console.WriteLine (p1.X); // 7
Console.WriteLine (p2.X); // 7

p1.X = 9;              // Change p1.X
Console.WriteLine (p1.X); // 9
Console.WriteLine (p2.X); // 9

```

Figure 4 shows that `p1` and `p2` are two references that point to the same object.

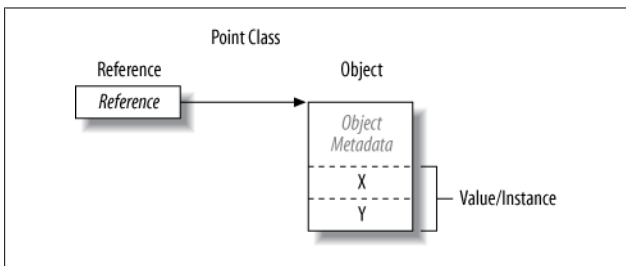

Figure 3. A reference-type instance in memory

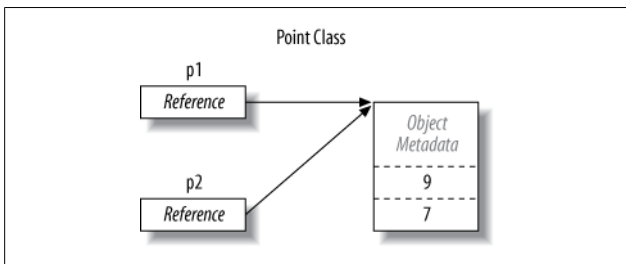

Figure 4. Assignment copies a reference

## Null

A reference can be assigned the literal `null`, indicating that the reference points to no object. Assuming `Point` is a class:

```

Point p = null;
Console.WriteLine (p == null); // True

```

Accessing a member of a null reference generates a runtime error:

```
Console.WriteLine (p.X); // NullReferenceException
```

In contrast, a value type cannot ordinarily have a null value:

```
struct Point {...}
...
Point p = null; // Compile-time error
int x = null; // Compile-time error
```

---

### NOTE

C# has a special construct, called *nullable types*, for representing value-type nulls (see the section “[Nullable Types](#)” on page 130).

---

## Predefined Type Taxonomy

The predefined types in C# are:

### *Value types*

- Numeric
  - Signed integer (sbyte, short, int, long)
  - Unsigned integer (byte, ushort, uint, ulong)
  - Real number (float, double, decimal)
- Logical (bool)
- Character (char)

### *Reference types*

- String (string)
- Object (object)

Predefined types in C# alias Framework types in the System namespace. There is only a syntactic difference between these two statements:

```
int i = 5;
System.Int32 i = 5;
```



The set of predefined *value* types, excluding `decimal`, are known as *primitive types* in the Common Language Runtime (CLR). Primitive types are so called because they are supported directly via instructions in compiled code, which usually translates to direct support on the underlying processor.

## Numeric Types

C# has the following predefined numeric types:

C# type	System type	Suffix	Size	Range
<b>Integral—signed</b>				
<code>sbyte</code>	<code>SByte</code>		8 bits	$-2^7$ to $2^7-1$
<code>short</code>	<code>Int16</code>		16 bits	$-2^{15}$ to $2^{15}-1$
<code>int</code>	<code>Int32</code>		32 bits	$-2^{31}$ to $2^{31}-1$
<code>long</code>	<code>Int64</code>	<code>L</code>	64 bits	$-2^{63}$ to $2^{63}-1$
<b>Integral—unsigned</b>				
<code>byte</code>	<code>Byte</code>		8 bits	0 to $2^8-1$
<code>ushort</code>	<code>UInt16</code>		16 bits	0 to $2^{16}-1$
<code>uint</code>	<code>UInt32</code>	<code>U</code>	32 bits	0 to $2^{32}-1$
<code>ulong</code>	<code>UInt64</code>	<code>UL</code>	64 bits	0 to $2^{64}-1$
<b>Real</b>				
<code>float</code>	<code>Single</code>	<code>F</code>	32 bits	$\pm(\sim 10^{-45}$ to $10^{38})$
<code>double</code>	<code>Double</code>	<code>D</code>	64 bits	$\pm(\sim 10^{-324}$ to $10^{308})$
<code>decimal</code>	<code>Decimal</code>	<code>M</code>	128 bits	$\pm(\sim 10^{-28}$ to $10^{28})$

Of the *integral* types, `int` and `long` are first-class citizens and are favored by both C# and the runtime. The other integral types are typically used for interoperability or when space efficiency is paramount.

Of the *real* number types, `float` and `double` are called *floating-point types* and are typically used for scientific calculations. The `decimal` type is typically used for financial calculations, where

base-10-accurate arithmetic and high precision are required. (Technically, `decimal` is a floating-point type too, although it's not generally referred to as such.)

## Numeric Literals

*Integral literals* can use decimal or hexadecimal notation; hexadecimal is denoted with the `0x` prefix (for example, `0x7f` is equivalent to `127`). *Real literals* may use decimal or exponential notation, such as `1E06`.

### Numeric literal type inference

By default, the compiler *infers* a numeric literal to be either `double` or an integral type:

- If the literal contains a decimal point or the exponential symbol (E), it is a `double`.
- Otherwise, the literal's type is the first type in this list that can fit the literal's value: `int`, `uint`, `long`, and `ulong`.

For example:

```
Console.Write (    1.0.GetType()); // Double (double)
Console.Write (   1E06.GetType()); // Double (double)
Console.Write (    1.GetType());  // Int32 (int)
Console.Write (0xF000000.GetType()); // UInt32 (uint)
```

### Numeric suffixes

The *numeric suffixes* listed in the preceding table explicitly define the type of a literal:

```
decimal d = 3.5M; // M = decimal (case-insensitive)
```

The suffixes `U` and `L` are rarely necessary, because the `uint`, `long`, and `ulong` types can nearly always be either *inferred* or *implicitly converted* from `int`:

```
long i = 5; // Implicit conversion from int to long
```

The `D` suffix is technically redundant, in that all literals with a decimal point are inferred to be `double` (and you can always add a decimal point to a numeric literal). The `F` and `M` suffixes

are the most useful and are mandatory when specifying fractional `float` or `decimal` literals. Without suffixes, the following would not compile, because `4.5` would be inferred to be of type `double`, which has no implicit conversion to `float` or `decimal`:

```
float f = 4.5F;      // Won't compile without suffix
decimal d = -1.23M; // Won't compile without suffix
```

## Numeric Conversions

### Integral to integral conversions

Integral conversions are *implicit* when the destination type can represent every possible value of the source type. Otherwise, an *explicit* conversion is required. For example:

```
int x = 12345;      // int is a 32-bit integral
long y = x;        // Implicit conversion to 64-bit int
short z = (short)x; // Explicit conversion to 16-bit int
```

### Real to real conversions

A `float` can be implicitly converted to a `double`, since a `double` can represent every possible `float` value. The reverse conversion must be explicit.

Conversions between `decimal` and other real types must be explicit.

### Real to integral conversions

Conversions from integral types to real types are implicit, whereas the reverse must be explicit. Converting from a floating-point to an integral truncates any fractional portion; to perform rounding conversions, use the static `System.Convert` class.

A caveat is that implicitly converting a large integral type to a floating-point type preserves *magnitude* but may occasionally lose *precision*:

```
int i1 = 100000001;
float f = i1;      // Magnitude preserved, precision lost
int i2 = (int)f;   // 100000000
```

## Arithmetic Operators

The arithmetic operators (+, -, \*, /, %) are defined for all numeric types except the 8- and 16-bit integral types. The % operator evaluates the remainder after division.

## Increment and Decrement Operators

The increment and decrement operators (++ , --) increment or decrement numeric types by 1. The operator can either precede or follow the variable, depending on whether you want the variable to be updated *before* or *after* the expression is evaluated. For example:

```
int x = 0;
Console.WriteLine (x++); // Outputs 0; x is now 1
Console.WriteLine (++x); // Outputs 2; x is now 2
Console.WriteLine (--x); // Outputs 1; x is now 1
```

## Specialized Integral Operations

### Integral division

Division operations on integral types always truncate remainders. Dividing by a variable whose value is zero generates a runtime error (a `DivideByZeroException`). Dividing by the *literal* 0 generates a compile-time error.

### Integral overflow

At runtime, arithmetic operations on integral types can overflow. By default, this happens silently—no exception is thrown. While the C# specification is agnostic as to the result of an overflow, the CLR always causes wraparound behavior. For example, decrementing the minimum possible `int` value results in the maximum possible `int` value:

```
int a = int.MinValue; a--;
Console.WriteLine (a == int.MaxValue); // True
```

## The checked and unchecked operators

The checked operator tells the runtime to generate an `OverflowException` rather than failing silently when an integral expression or statement exceeds the arithmetic limits of that type. The checked operator affects expressions with the `++`, `--`, (unary) `-`, `+`, `-`, `*`, `/`, and explicit conversion operators between integral types.

`checked` can be used around either an expression or a statement block. For example:

```
int a = 1000000, int b = 1000000;

int c = checked (a * b);    // Checks just the expression

checked                    // Checks all expressions
{                          // in statement block.
    c = a * b;
    ...
}
```

You can make arithmetic overflow checking the default for all expressions in a program by compiling with the `/checked+` command-line switch (in Visual Studio, go to Advanced Build Settings). If you then need to disable overflow checking just for specific expressions or statements, you can do so with the `unchecked` operator.

## Bitwise operators

C# supports the following bitwise operations:

Operator	Meaning	Sample expression	Result
<code>~</code>	Complement	<code>~0xfU</code>	<code>0xffffffff0U</code>
<code>&amp;</code>	And	<code>0xf0 &amp; 0x33</code>	<code>0x30</code>
<code> </code>	Or	<code>0xf0   0x33</code>	<code>0xf3</code>
<code>^</code>	Exclusive Or	<code>0xff00 ^ 0x0ff0</code>	<code>0xf0f0</code>
<code>&lt;&lt;</code>	Shift left	<code>0x20 &lt;&lt; 2</code>	<code>0x80</code>
<code>&gt;&gt;</code>	Shift right	<code>0x20 &gt;&gt; 1</code>	<code>0x10</code>

## 8- and 16-Bit Integrals

The 8- and 16-bit integral types are `byte`, `sbyte`, `short`, and `ushort`. These types lack their own arithmetic operators, so C# implicitly converts them to larger types as required. This can cause a compilation error when trying to assign the result back to a small integral type:

```
short x = 1, y = 1;
short z = x + y;           // Compile-time error
```

In this case, `x` and `y` are implicitly converted to `int` so that the addition can be performed. This means the result is also an `int`, which cannot be implicitly cast back to a `short` (because it could cause loss of data). To make this compile, we must add an explicit cast:

```
short z = (short) (x + y); // OK
```

## Special Float and Double Values

Unlike integral types, floating-point types have values that certain operations treat specially. These special values are NaN (Not a Number),  $+\infty$ ,  $-\infty$ , and  $-0$ . The `float` and `double` classes have constants for NaN,  $+\infty$ , and  $-\infty$  (as well as other values, including `MaxValue`, `MinValue`, and `Epsilon`). For example:

```
Console.Write (double.NegativeInfinity); // -Infinity
```

Dividing a nonzero number by zero results in an infinite value:

```
Console.WriteLine ( 1.0 / 0.0); // Infinity
Console.WriteLine (-1.0 / 0.0); // -Infinity
Console.WriteLine ( 1.0 / -0.0); // -Infinity
Console.WriteLine (-1.0 / -0.0); // Infinity
```

Dividing zero by zero, or subtracting infinity from infinity, results in a NaN:

```
Console.Write ( 0.0 / 0.0); // NaN
Console.Write ((1.0 / 0.0) - (1.0 / 0.0)); // NaN
```

When using `==`, a NaN value is never equal to another value, even another NaN value. To test whether a value is NaN, you must use the `float.IsNaN` or `double.IsNaN` method:

```
Console.WriteLine (0.0 / 0.0 == double.NaN); // False
Console.WriteLine (double.IsNaN (0.0 / 0.0)); // True
```

When using `object.Equals`, however, two NaN values are equal:

```
bool isTrue = object.Equals (0.0/0.0, double.NaN);
```

## double Versus decimal

`double` is useful for scientific computations (such as computing spatial coordinates). `decimal` is useful for financial computations and values that are “man-made” rather than the result of real-world measurements. Here’s a summary of the differences:

Feature	double	decimal
Internal representation	Base 2	Base 10
Precision	15-16 significant figures	28–29 significant figures
Range	$\pm(\sim 10^{-324}$ to $\sim 10^{308})$	$\pm(\sim 10^{-28}$ to $\sim 10^{28})$
Special values	+0, -0, +∞, -∞, and NaN	None
Speed	Native to processor	Nonnative to processor (about 10 times slower than double)

## Real Number Rounding Errors

`float` and `double` internally represent numbers in base-2. For this reason, most literals with a fractional component (which are in base-10) will not be represented precisely:

```
float tenth = 0.1f; // Not quite 0.1
float one = 1f;
Console.WriteLine (one - tenth * 10f); // -1.490116E-08
```

This is why `float` and `double` are bad for financial calculations. In contrast, `decimal` works in base-10 and can precisely represent fractional numbers such as 0.1 (whose base-10 representation is nonrecurring).

## Boolean Type and Operators

C#'s `bool` type (aliasing the `System.Boolean` type) is a logical value that can be assigned the literal `true` or `false`.

Although a Boolean value requires only one bit of storage, the runtime will use one byte of memory, since this is the minimum chunk that the runtime and processor can efficiently work with. To avoid space-inefficiency in the case of arrays, the Framework provides a `BitArray` class in the `System.Collections` namespace, designed to use just one bit per Boolean value.

## Equality and Comparison Operators

`==` and `!=` test for equality and inequality of any type, and always return a `bool` value. Value types typically have a very simple notion of equality:

```
int x = 1, y = 2, z = 1;
Console.WriteLine (x == y);    // False
Console.WriteLine (x == z);    // True
```

For reference types, equality, by default, is based on *reference*, as opposed to the actual *value* of the underlying object. Therefore, two instances of an object with identical data are not considered equal unless the `==` operator for that type is specially overloaded to that effect (see the section “[The object Type](#)” on page 78 and the section “[Operator Overloading](#)” on page 135).

The equality and comparison operators, `==`, `!=`, `<`, `>`, `>=`, and `<=`, work for all numeric types, but should be used with caution with real numbers (see “[Real Number Rounding Errors](#)” on page 25 in the previous section). The comparison operators also work on `enum` type members, by comparing their underlying integral values.



## Conditional Operators

The `&&` and `||` operators test for *and* and *or* conditions. They are frequently used in conjunction with the `!` operator, which expresses *not*. In this example, the `UseUmbrella` method returns `true` if it's rainy or sunny (to protect us from the rain or the sun), as long as it's not also windy (since umbrellas are useless in the wind):

```
static bool UseUmbrella (bool rainy, bool sunny,
                        bool windy)
{
    return !windy && (rainy || sunny);
}
```

The `&&` and `||` operators *short-circuit* evaluation when possible. In the preceding example, if it is windy, the expression `(rainy || sunny)` is not even evaluated. Short circuiting is essential in allowing expressions such as the following to run without throwing a `NullReferenceException`:

```
if (sb != null && sb.Length > 0) ...
```

The `&` and `|` operators also test for *and* and *or* conditions:

```
return !windy & (rainy | sunny);
```

The difference is that they *do not short-circuit*. For this reason, they are rarely used in place of conditional operators.

The ternary conditional operator (simply called the *conditional operator*) has the form `q ? a : b`, where if condition `q` is true, `a` is evaluated, else `b` is evaluated. For example:

```
static int Max (int a, int b)
{
    return (a > b) ? a : b;
}
```

The conditional operator is particularly useful in LINQ queries.

Download from Library of Wow! eBook  
<[www.wowebook.com](http://www.wowebook.com)>

## Strings and Characters

C#'s `char` type (aliasing the `System.Char` type) represents a Unicode character and occupies two bytes. A `char` literal is specified inside single quotes:

```
char c = 'A';    // Simple character
```

*Escape sequences* express characters that cannot be expressed or interpreted literally. An escape sequence is a backslash followed by a character with a special meaning. For example:

```
char newLine = '\n';
char backSlash = '\\';
```

The escape sequence characters are:

Char	Meaning	Value
\'	Single quote	0x0027
\"	Double quote	0x0022
\\	Backslash	0x005C
\0	Null	0x0000
\a	Alert	0x0007
\b	Backspace	0x0008
\f	Form feed	0x000C
\n	New line	0x000A
\r	Carriage return	0x000D
\t	Horizontal tab	0x0009
\v	Vertical tab	0x000B

The `\u` (or `\x`) escape sequence lets you specify any Unicode character via its four-digit hexadecimal code.

```
char copyrightSymbol = '\u00A9';
char omegaSymbol     = '\u03A9';
char newLine         = '\u000A';
```

An implicit conversion from a `char` to a numeric type works for the numeric types that can accommodate an unsigned `short`. For other numeric types, an explicit conversion is required.

## String Type

C#'s string type (aliasing the `System.String` type) represents an immutable sequence of Unicode characters. A string literal is specified inside double quotes:

```
string a = "Heat";
```

---

### NOTE

`string` is a reference type, rather than a value type. Its equality operators, however, follow value-type semantics:

```
string a = "test", b = "test";
Console.Write (a == b); // True
```

---

The escape sequences that are valid for `char` literals also work inside strings:

```
string a = "Here's a tab:\t";
```

The cost of this is that whenever you need a literal backslash, you must write it twice:

```
string a1 = "\\server\fileshare\helloworld.cs";
```

To avoid this problem, C# allows *verbatim* string literals. A verbatim string literal is prefixed with `@` and does not support escape sequences. The following verbatim string is identical to the preceding one:

```
string a2 = @"server\fileshare\helloworld.cs";
```

A verbatim string literal can also span multiple lines. You can include the double quote character in a verbatim literal by writing it twice.

## String concatenation

The `+` operator concatenates two strings:

```
string s = "a" + "b";
```

The righthand operand may be a non-string value, in which case `ToString` is called on that value. For example:

```
string s = "a" + 5; // a5
```

Since `string` is immutable, using the `+` operator repeatedly to build up a string can be inefficient. The solution is to instead use the `System.Text.StringBuilder` type—this represents a mutable (editable) string, and has methods to efficiently `Append`, `Insert`, `Remove` and `Replace` substrings.

## String comparisons

`string` does not support `<` and `>` operators for comparisons. You must instead use `string`'s `CompareTo` method, which returns a positive number, a negative number, or zero, depending on whether the first value comes after, before, or alongside the second value:

```
Console.Write ("Boston".CompareTo ("Austin")); // 1
Console.Write ("Boston".CompareTo ("Boston")); // 0
Console.Write ("Boston".CompareTo ("Chicago")); // -1
```

## Searching within strings

`string`'s indexer returns a character at a specified position:

```
Console.Write ("word"[2]); // r
```

The `IndexOf/LastIndexOf` methods search for a character within the string; the `Contains`, `StartsWith` and `EndsWith` methods search for a substring within the string.

## Manipulating strings

Because `string` is immutable, all the methods that “manipulate” a string return a new one, leaving the original untouched:

- `Substring` extracts a portion of a string.
- `Insert` and `Remove` insert and remove characters at a specified position.
- `PadLeft` and `PadRight` add whitespace.
- `TrimStart`, `TrimEnd`, and `Trim` remove whitespace.

The `string` class also defines `ToUpper` and `ToLower` methods for changing case, a `Split` method to split a string into substrings (based on supplied delimiters), and a static `Join` method to join substrings back into a string.

## Arrays

An array represents a fixed number of elements of a particular type. The elements in an array are always stored in a contiguous block of memory, providing highly efficient access.

An array is denoted with square brackets after the element type. The following declares an array of 5 characters:

```
char[] vowels = new char[5];
```

Square brackets also *index* the array, accessing a particular element by position:

```
vowels[0] = 'a'; vowels[1] = 'e'; vowels[2] = 'i';  
vowels[3] = 'o'; vowels[4] = 'u';
```

```
Console.WriteLine (vowels [1]);    // e
```

This prints “e” because array indexes start at 0. We can use a `for` loop statement to iterate through each element in the array. The `for` loop in this example cycles the integer `i` from 0 to 4:

```
for (int i = 0; i < vowels.Length; i++)  
    Console.Write (vowels [i]);    // aeiou
```

Arrays also implement `IEnumerable<T>` (see [“Enumeration and Iterators” on page 125](#)), so you can also enumerate members with the `foreach` statement:

```
foreach (char c in vowels) Console.Write (c); // aeiou
```

All array indexing is bounds-checked by the runtime. An `IndexOutOfRangeException` is thrown if you use an invalid index:

```
vowels[5] = 'y'; // Runtime error
```

The `Length` property of an array returns the number of elements in the array. Once an array has been created, its length cannot be changed. The `System.Collection` namespace and subnamespaces provide higher-level data structures, such as dynamically sized arrays and dictionaries.

An *array initialization expression* lets you declare and populate an array in a single step:

```
char[] vowels = new char[] { 'a', 'e', 'i', 'o', 'u' };
```

or simply:

```
char[] vowels = { 'a', 'e', 'i', 'o', 'u' };
```

All arrays inherit from the `System.Array` class, which defines common methods and properties for all arrays. This includes instance properties such as `Length` and `Rank`, and static methods to:

- Dynamically create an array (`CreateInstance`)
- Get and set elements regardless of the array type (`GetValue/SetValue`)
- Search a sorted array (`BinarySearch`) or an unsorted array (`IndexOf`, `LastIndexOf`, `Find`, `FindIndex`, `FindLastIndex`)
- Sort an array (`Sort`)
- Copy an array (`Copy`)

## Default Element Initialization

Creating an array always pre-initializes the elements with default values. The default value for a type is the result of a bitwise zeroing of memory. For example, consider creating an array of integers. Since `int` is a value type, this allocates 1,000 integers in one contiguous block of memory. The default value for each element will be 0:

```
int[] a = new int[1000];
Console.Write (a[123]);           // 0
```

With reference-type elements, the default value is `null`.

An array *itself* is always a reference type object, regardless of element type. For instance, the following is legal:

```
int[] a = null;
```

## Multidimensional Arrays

Multidimensional arrays come in two varieties: *rectangular* and *jagged*. Rectangular arrays represent an  $n$ -dimensional block of memory, and jagged arrays are arrays of arrays.

### Rectangular arrays

Rectangular arrays are declared using commas to separate each dimension. The following declares a rectangular two-dimensional array, where the dimensions are  $3 \times 3$ :

```
int[,] matrix = new int [3, 3];
```

The `GetLength` method of an array returns the length for a given dimension (starting at 0):

```
for (int i = 0; i < matrix.GetLength(0); i++)
    for (int j = 0; j < matrix.GetLength(1); j++)
        matrix [i, j] = i * 3 + j;
```

A rectangular array can be initialized as follows (each element in this example is initialized to be identical to the previous example):

```
int[,] matrix = new int[,]
{
    {0,1,2},
    {3,4,5},
    {6,7,8}
};
```

(The code shown in boldface can be omitted in declaration statements such as the one above.)

## Jagged arrays

Jagged arrays are declared using successive square brackets to represent each dimension. Here is an example of declaring a jagged two-dimensional array, where the outermost dimension is 3:

```
int[][] matrix = new int[3][];
```

The inner dimensions aren't specified in the declaration. Unlike a rectangular array, each inner array can be an arbitrary length. Each inner array is implicitly initialized to null rather than an empty array. Each inner array must be created manually:

```
for (int i = 0; i < matrix.Length; i++)
{
    matrix[i] = new int [3];           // Create inner array
    for (int j = 0; j < matrix[i].Length; j++)
        matrix[i][j] = i * 3 + j;
}
```

A jagged array can be initialized as follows (each element in this example is initialized to be identical to the previous example):

```
int[][] matrix = new int[][]
{
    new int[] {0,1,2},
    new int[] {3,4,5},
    new int[] {6,7,8}
};
```

(The code shown in boldface can be omitted in declaration statements such as the above.)

## Simplified Array Initialization Expressions

We've already seen how to simplify array initialization expressions by omitting the `new` keyword and type declaration:

```
char[] vowels = new char[] {'a','e','i','o','u'};
char[] vowels =          {'a','e','i','o','u'};
```



Another approach is to omit the type name after the `new` keyword, and have the compiler *infer* the array type. This is a useful shortcut when passing arrays as arguments. For example, consider the following method:

```
void Foo (char[] data) { ... }
```

We can call this method with an array that we create on the fly, as follows:

```
Foo ( new char[] { 'a', 'e', 'i', 'o', 'u' } ); // Longhand
Foo ( new[]      { 'a', 'e', 'i', 'o', 'u' } ); // Shortcut
```

This shortcut is essential in creating arrays of *anonymous types*, as we'll see later.

## Variables and Parameters

A variable represents a storage location that has a modifiable value. A variable can be a *local variable*, *parameter (value, ref, or out)*, *field (instance or static)*, or *array element*.

### The Stack and the Heap

The stack and the heap are the places where variables and constants reside. Each has very different lifetime semantics.

#### Stack

The stack is a block of memory for storing local variables and parameters. The stack logically grows and shrinks as a function is entered and exited. Consider the following method (to avoid distraction, input argument checking is ignored):

```
static int Factorial (int x)
{
    if (x == 0) return 1;
    return x * Factorial (x-1);
}
```

This method is recursive, meaning that it calls itself. Each time the method is entered, a new `int` is allocated on the stack, and each time the method exits, the `int` is deallocated.

## Heap

The heap is a block of memory in which *objects* (i.e., reference-type instances) reside. Whenever a new object is created, it is allocated on the heap, and a reference to that object is returned. During a program's execution, the heap starts filling up as new objects are created. The runtime has a garbage collector that periodically deallocates objects from the heap, so your computer does not run out of memory. An object is eligible for deallocation as soon as nothing references it.

Value-type instances (and object references) live wherever the variable was declared. If the instance was declared as a field within an object, or as an array element, that instance lives on the heap.

---

### NOTE

You can't explicitly delete objects in C#, as you can in C++. An unreferenced object is eventually collected by the garbage collector.

---

The heap also stores static fields and constants. Unlike objects allocated on the heap (which can get garbage-collected), these live until the application domain is torn down.

## Definite Assignment

C# enforces a definite assignment policy. In practice, this means that outside of an *unsafe* context, it's impossible to access uninitialized memory. Definite assignment has three implications:

- Local variables must be assigned a value before they can be read.
- Function arguments must be supplied when a method is called (unless marked optional—see [“Optional parameters \(C# 4.0\)”](#) on page 40).

- All other variables (such as fields and array elements) are automatically initialized by the runtime.

For example, the following code results in a compile-time error:

```
static void Main()
{
    int x;
    Console.WriteLine (x);      // Compile-time error
}
```

However, if *x* were instead a *field* of the containing class, this would be legal and would print 0.

## Default Values

All type instances have a default value. The default value for the predefined types is the result of a bitwise zeroing of memory, and is `null` for reference types, `0` for numeric and enum types, `'\0'` for the `char` type, and `false` for the `bool` type.

You can obtain the default value for any type using the `default` keyword (in practice, this is useful with generics, as we'll see later). The default value in a custom value type (i.e., `struct`) is the same as the default value for each field defined by the custom type.

## Parameters

A method has a sequence of parameters. Parameters define the set of arguments that must be provided for that method. In this example, the method `Foo` has a single parameter named *p*, of type `int`:

```
static void Foo (int p)    // p is a parameter
{
    ...
}
static void Main() { Foo (8); }    // 8 is an argument
```

You can control how parameters are passed with the `ref` and `out` modifiers:

Parameter modifier	Passed by	Variable must be definitely assigned
None	Value	Going <i>in</i>
Ref	Reference	Going <i>in</i>
out	Reference	Going <i>out</i>

## Passing arguments by value

By default, arguments in C# are *passed by value*, which is by far the most common case. This means a copy of the value is created when passed to the method:

```
static void Foo (int p)
{
    p = p + 1;           // Increment p by 1
    Console.WriteLine (p); // Write p to screen
}
static void Main()
{
    int x = 8;
    Foo (x);           // Make a copy of x
    Console.WriteLine (x); // x will still be 8
}
```

Assigning `p` a new value does not change the contents of `x`, since `p` and `x` reside in different memory locations.

Passing a reference-type argument by value copies the *reference*, but not the object. In the following example, `Foo` sees the same `StringBuilder` object that `Main` instantiated, but has an independent *reference* to it. In other words, `sb` and `fooSB` are separate variables that reference the same `StringBuilder` object:

```
static void Foo (StringBuilder fooSB)
{
    fooSB.Append ("test");
    fooSB = null;
}
static void Main()
{
```

```

    StringBuilder sb = new StringBuilder();
    Foo (sb);
    Console.WriteLine (sb.ToString());    // test
}

```

Because `fooSB` is a *copy* of a reference, setting it to `null` doesn't make `sb` `null`. (If, however, `fooSB` was declared and called with the `ref` modifier, `sb` *would* become `null`.)

## The ref modifier

To *pass by reference*, C# provides the `ref` parameter modifier. In the following example, `p` and `x` refer to the same memory locations:

```

static void Foo (ref int p)
{
    p = p + 1;
    Console.WriteLine (p);
}
static void Main()
{
    int x = 8;
    Foo (ref x);           // Pass x by reference
    Console.WriteLine (x); // x is now 9
}

```

Now assigning `p` a new value changes the contents of `x`. Notice how the `ref` modifier is required both when writing and when calling the method. This makes it very clear what's going on.

---

### NOTE

A parameter can be passed by reference or by value, regardless of whether the parameter type is a reference type or a value type.

---

## The out modifier

An `out` argument is like a `ref` argument, except it:

- Need not be assigned before going into the function
- Must be assigned before it comes *out* of the function

The `out` modifier is most commonly used to get multiple return values back from a method.

## The params modifier

The `params` parameter modifier may be specified on the last parameter of a method so that the method accepts any number of parameters of a particular type. The parameter type must be declared as an array. For example:

```
static int Sum (params int[] ints)
{
    int sum = 0;
    for (int i = 0; i < ints.Length; i++) sum += ints[i];
    return sum;
}
```

We can call this as follows:

```
Console.WriteLine (Sum (1, 2, 3, 4));    // 10
```

You can also supply a `params` argument as an ordinary array. The preceding call is semantically equivalent to:

```
Console.WriteLine (new int[] { 1, 2, 3, 4 } );
```

## Optional parameters (C# 4.0)

From C# 4.0, methods, constructors, and indexers can declare *optional parameters*. A parameter is optional if it specifies a *default value* in its declaration:

```
void Foo (int x = 23) { Console.WriteLine (x); }
```

Optional parameters may be omitted when calling the method:

```
Foo();    // 23
```

The *default argument* of `23` is actually *passed* to the optional parameter `x`—the compiler bakes the value `23` into the compiled code at the *calling* side. The preceding call to `Foo` is semantically identical to:

```
Foo (23);
```

because the compiler simply substitutes the default value of an optional parameter wherever it is used.

---

**WARNING**

Adding an optional parameter to a public method that's called from another assembly requires recompilation of both assemblies—just as though the parameter were mandatory.

---

The default value of an optional parameter must be specified by a constant expression, or a parameterless constructor of a value type. Optional parameters cannot be marked with `ref` or `out`.

Mandatory parameters must occur *before* optional parameters in both the method declaration and method call (the exception is with `params` arguments, which still always come last). In the following example, the explicit value of `1` is passed to `x`, and the default value of `0` is passed to `y`:

```
void Foo (int x = 0, int y = 0)
{
    Console.WriteLine (x + ", " + y);
}
void Test()
{
    Foo(1);    // 1, 0
}
```

To do the converse (pass a default value to `x` and an explicit value to `y`) you must combine optional parameters with *named arguments*.

### Named arguments (C# 4.0)

Rather than identifying an argument by position, you can identify an argument by name. For example:

```
void Foo (int x, int y)
{
    Console.WriteLine (x + ", " + y);
}
void Test()
{
```

```
    Foo (x:1, y:2); // 1, 2
}
```

Named arguments can occur in any order. The following calls to `Foo` are semantically identical:

```
Foo (x:1, y:2);
Foo (y:2, x:1);
```

You can mix named and positional parameters, as long as the named arguments appear last:

```
Foo (1, y:2);
```

Named arguments are particularly useful in conjunction with optional parameters. For instance, consider the following method:

```
void Bar (int a=0, int b=0, int c=0, int d=0) { ... }
```

We can call this by supplying only a value for `d` as follows:

```
Bar (d:3);
```

This is particularly useful when calling COM APIs.

## var—Implicitly Typed Local Variables

It is often the case that you declare and initialize a variable in one step. If the compiler is able to infer the type from the initialization expression, you can use the word `var` in place of the type declaration. For example:

```
var x = "hello";
var y = new System.Text.StringBuilder();
var z = (float)Math.PI;
```

This is precisely equivalent to:

```
string x = "hello";
System.Text.StringBuilder y =
    new System.Text.StringBuilder();
float z = (float)Math.PI;
```

Because of this direct equivalence, implicitly typed variables are statically typed. For example, the following generates a compile-time error:



```
var x = 5;
x = "hello";    // Compile-time error; x is of type int
```

In the section “[Anonymous Types](#)” on page 140, we describe a scenario where the use of `var` is mandatory.

## Expressions and Operators

An *expression* essentially denotes a value. The simplest kinds of expressions are constants (such as `123`) and variables (such as `x`). Expressions can be transformed and combined using operators. An *operator* takes one or more input *operands* to output a new expression:

```
12 * 30    // * is an operator; 12 and 30 are operands.
```

Complex expressions can be built because an operand may itself be an expression, such as the operand `(12 * 30)` in the following example:

```
1 + (12 * 30)
```

Operators in C# are classed as *unary*, *binary*, or *ternary*—depending on the number of operands they work on (one, two, or three). The binary operators always use *infix* notation, where the operator is placed *between* the two operands.

Operators that are intrinsic to the basic plumbing of the language are called *primary*; an example is the method call operator. An expression that has no value is called a *void expression*:

```
Console.WriteLine (1)
```

Since a void expression has no value, it cannot be used as an operand to build more complex expressions:

```
1 + Console.WriteLine (1)    // Compile-time error
```

## Assignment Expressions

An assignment expression uses the `=` operator to assign the result of another expression to a variable. For example:

```
x = x * 5
```

An assignment expression is not a void expression. It actually carries the assignment value, and so can be incorporated into another expression. In the following example, the expression assigns 2 to `x` and 10 to `y`:

```
y = 5 * (x = 2)
```

This style of expression can be used to initialize multiple values:

```
a = b = c = d = 0
```

The *compound assignment operators* are syntactic shortcuts that combine assignment with another operator. For example:

```
x *= 2    // equivalent to x = x * 2
x <<= 1   // equivalent to x = x << 1
```

(A subtle exception to this rule is with *events*, described further in “[Event Accessors](#)” on page 111: the `+=` and `-=` operators here are treated specially, and map to the event’s `add` and `remove` accessors).

## Operator Precedence and Associativity

When an expression contains multiple operators, *precedence* and *associativity* determine the order of evaluation. Operators with higher precedence execute before operators of lower precedence. If the operators have the same precedence, the operator’s associativity determines the order of evaluation.

### Precedence

The expression `1 + 2 * 3` is evaluated as `1 + (2 * 3)` because `*` has a higher precedence than `+`.

### Left-associative operators

Binary operators (except for assignment, lambda, and null coalescing operators) are *left-associative*; in other words, they are evaluated from left to right. For example, the expression `8/4/2` is evaluated as `(8/4)/2` due to left associativity. Of course, you can insert your own parentheses to change evaluation order.

## Right-associative operators

The *assignment operators*, lambda, null coalescing and conditional operator are *right-associative*; in other words, they are evaluated from right to left. Right associativity allows multiple assignments such as `x=y=3` to compile: it works by first assigning 3 to `y`, and then assigning the result of that expression (3) to `x`.

## Operator Table

The following table lists C#'s operators in order of precedence. Operators listed under the same subheading have the same precedence. We explain user-overloadable operators in the section “[Operator Overloading](#)” on page 135.

Operator symbol	Operator name	Example	Overloadable
<b>Primary (highest precedence)</b>			
()	Grouping	<code>while(x)</code>	No
.	Member access	<code>x.y</code>	No
->	Pointer to struct (unsafe)	<code>x-&gt;y</code>	No
()	Function call	<code>x()</code>	No
[]	Array/index	<code>a[x]</code>	Via indexer
++	Post-increment	<code>x++</code>	Yes
--	Post-decrement	<code>x--</code>	Yes
new	Create instance	<code>new Foo()</code>	No
<code>stackalloc</code>	Unsafe stack allocation	<code>stackalloc(10)</code>	No
<code>typeof</code>	Get type from identifier	<code>typeof(int)</code>	No
checked	Integral overflow check on	<code>checked(x)</code>	No
unchecked	Integral overflow check off	<code>unchecked(x)</code>	No

Unary			
sizeof	Get size of struct	sizeof(int)	No
+	Positive value of	+x	Yes
-	Negative value of	-x	Yes
!	Not	!x	Yes
~	Bitwise complement	~x	Yes
++	Pre-increment	++x	Yes
--	Pre-decrement	--x	Yes
()	Cast	(int)x	No
*	Value at address (unsafe)	*x	No
&	Address of value (unsafe)	&x	No
Multiplicative			
*	Multiply	x * y	Yes
/	Divide	x / y	Yes
%	Remainder	x % y	Yes
Additive			
+	Add	x + y	Yes
-	Subtract	x - y	Yes
Shift			
<<	Shift left	x >> 1	Yes
>>	Shift right	x << 1	Yes
Relational			
<	Less than	x < y	Yes
>	Greater than	x > y	Yes
<=	Less than or equal to	x <= y	Yes
>=	Greater than or equal to	x >= y	Yes
is	Type is or is subclass of	x is y	No

<b>Relational</b>			
as	Type conversion	x as y	No
<b>Equality</b>			
==	Equals	x == y	Yes
!=	Not equals	x != y	Yes
<b>Logical And</b>			
&	And	x & y	Yes
<b>Logical Xor</b>			
^	Exclusive Or	x ^ y	Yes
<b>Logical Or</b>			
	Or	x   y	Yes
<b>Conditional And</b>			
&&	Conditional And	x && y	Via &
<b>Conditional Or</b>			
	Conditional Or	x    y	Via
<b>Conditional</b>			
? :	Conditional	isTrue ? thenThis : elseThis	No
<b>Assignment</b>			
=	Assign	x = y	No
*=	Multiply self by	x *= 2	Via *
/=	Divide self by	x /= 2	Via /
+=	Add to self	x += 2	Via +
--	Subtract from self	x -= 2	Via -
<<=	Shift self left by	x <<= 2	Via <<
>>=	Shift self right by	x >>= 2	Via >>
&=	And self by	x &= 2	Via &
^=	Exclusive-Or self by	x ^= 2	Via ^
=	Or self by	x  = 2	Via

**Lambda (lowest precedence)**

=>	Lambda	x => x + 1	No
----	--------	------------	----

## Statements

Functions comprise statements that execute sequentially in the textual order in which they appear. A *statement block* is a series of statements appearing between braces (the {} tokens).

## Declaration Statements

A declaration statement declares a new variable, optionally initializing the variable with an expression. A declaration statement ends in a semicolon. You may declare multiple variables of the same type in a comma-separated list. For example:

```
bool rich = true, famous = false;
```

A constant declaration is like a variable declaration, except that the variable cannot be changed after it has been declared, and the initialization must occur with the declaration:

```
const double c = 2.99792458E08;
```

## Local variable scope

The scope of a local or constant variable extends throughout the current block. You cannot declare another local variable with the same name in the current block or in any nested blocks.

## Expression Statements

Expression statements are expressions that are also valid statements. In practice, this means expressions that “do” something; in other words, expressions that:

- Assign or modify a variable
- Instantiate an object
- Call a method

Expressions that do none of these are not valid statements:

```
string s = "foo";
s.Length;           // Illegal statement: does nothing!
```

When you call a constructor or a method that returns a value, you're not obliged to use the result. However, unless the constructor or method changes state, the statement is useless:

```
new StringBuilder(); // Legal, but useless
x.Equals (y);        // Legal, but useless
```

## Selection Statements

Selection statements conditionally control the flow of program execution.

### The if statement

An if statement executes a body of code depending on whether a `bool` expression is true. For example:

```
if (5 < 2 * 3)
{
    Console.WriteLine ("true");    // True
}
```

If the body of code is a single statement, you can optionally omit the braces:

```
if (5 < 2 * 3)
    Console.WriteLine ("true");    // True
```

### The else clause

An if statement is optionally followed by an else clause:

```
if (2 + 2 == 5)
    Console.WriteLine ("Does not compute");
else
    Console.WriteLine ("False");    // False
```

Within an else clause, you can nest another if statement:

```
if (2 + 2 == 5)
    Console.WriteLine ("Does not compute");
```

```

else
    if (2 + 2 == 4)
        Console.WriteLine ("Computes");    // Computes

```

## Changing the flow of execution with braces

An else clause always applies to the immediately preceding if statement in the statement block. For example:

```

if (true)
    if (false)
        Console.WriteLine();
    else
        Console.WriteLine ("executes");

```

This is semantically identical to:

```

if (true)
{
    if (false)
        Console.WriteLine();
    else
        Console.WriteLine ("executes");
}

```

We can change the execution flow by moving the braces:

```

if (true)
{
    if (false)
        Console.WriteLine();
}
else
    Console.WriteLine ("does not execute");

```

C# has no “elseif” keyword; however, the following pattern achieves the same result:

```

static void TellMeWhatICanDo (int age)
{
    if (age >= 35)
        Console.WriteLine ("You can be president!");
    else if (age >= 21)
        Console.WriteLine ("You can drink!");
    else if (age >= 18)
        Console.WriteLine ("You can vote!");
    else
        Console.WriteLine ("You can wait!");
}

```



## The switch statement

`switch` statements let you branch program execution based on a selection of possible values that a variable may have. `switch` statements may result in cleaner code than multiple `if` statements, since `switch` statements only require an expression to be evaluated once. For instance:

```
static void ShowCard (int cardNumber)
{
    switch (cardNumber)
    {
        case 13:
            Console.WriteLine ("King");
            break;
        case 12:
            Console.WriteLine ("Queen");
            break;
        case 11:
            Console.WriteLine ("Jack");
            break;
        default: // Any other cardNumber
            Console.WriteLine (cardNumber);
            break;
    }
}
```

You can only switch on an expression of a type that can be statically evaluated, which restricts it to the built-in integral types, `string` type, and `enum` types. At the end of each case clause, you must say explicitly where execution is to go next, with some kind of jump statement. Here are the options:

- `break` (jumps to the end of the `switch` statement)
- `goto case x` (jumps to another case clause)
- `goto default` (jumps to the `default` clause)
- Any other jump statement—namely, `return`, `throw`, `continue`, or `goto label`

When more than one value should execute the same code, you can list the common cases sequentially:

```

switch (cardNumber)
{
    case 13:
    case 12:
    case 11:
        Console.WriteLine ("Face card");
        break;
    default:
        Console.WriteLine ("Plain card");
        break;
}

```

This feature of a `switch` statement can be pivotal in terms of producing cleaner code than multiple `if-else` statements.

## Iteration Statements

C# enables a sequence of statements to execute repeatedly with the `while`, `do-while`, `for` and `foreach` statements.

### while and do-while loops

`while` loops repeatedly execute a body of code while a `bool` expression is true. The expression is tested *before* the body of the loop is executed. For example, the following writes 012:

```

int i = 0;
while (i < 3)
{
    Console.Write (i++);
}
// Braces here are optional

```

`do-while` loops differ in functionality from `while` loops, only in that they test the expression *after* the statement block has executed (ensuring that the block is always executed at least once). Here's the preceding example rewritten with a `do-while` loop:

```

int i = 0;
do
{
    Console.WriteLine (i++);
}
while (i < 3);

```

## for loops

`for` loops are like `while` loops with special clauses for *initialization* and *iteration* of a loop variable. A `for` loop contains three clauses as follows:

```
for (init-clause; condition-clause; iteration-clause)
    statement-or-statement-block
```

The *init-clause* executes before the loop begins, and typically initializes one or more *iteration* variables.

The *condition-clause* is a `bool` expression which is tested *before* each loop iteration. The body executes while this condition is true.

The *iteration-clause* is executed *after* each iteration of the body. It's typically used to update the iteration variable.

For example, the following prints the numbers 0 through 2:

```
for (int i = 0; i < 3; i++)
    Console.WriteLine (i);
```

The following prints the first 10 Fibonacci numbers (where each number is the sum of the previous two):

```
for (int i = 0, prevFib = 1, curFib = 1; i < 10; i++)
{
    Console.WriteLine (prevFib);
    int newFib = prevFib + curFib;
    prevFib = curFib; curFib = newFib;
}
```

Any of the three parts of the `for` statement may be omitted. One can implement an infinite loop such as the following (though `while(true)` may be used instead):

```
for (;;) Console.WriteLine ("interrupt me");
```

## foreach loops

The `foreach` statement iterates over each element in an enumerable object. Most of the types in C# and the .NET Framework that represent a set or list of elements are enumerable. For example, both an array and a string are enumerable. Here

is an example of enumerating over the characters in a string, from the first character to the last:

```
foreach (char c in "beer")
    Console.WriteLine (c + " "); // b e e r
```

We define enumerable objects in [“Enumeration and Iterators” on page 125](#).

## Jump Statements

The C# jump statements are `break`, `continue`, `goto`, `return`, and `throw`. We cover the `throw` keyword in [“try Statements and Exceptions” on page 117](#).

### The `break` statement

The `break` statement ends the execution of the body of an iteration or `switch` statement:

```
int x = 0;
while (true)
{
    if (x++ > 5) break; // break from the loop
}
// execution continues here after break
...
```

### The `continue` statement

The `continue` statement forgoes the remaining statements in the loop and makes an early start on the next iteration. The following loop *skips* even numbers:

```
for (int i = 0; i < 10; i++)
{
    if ((i % 2) == 0) continue;
    Console.Write (i + " "); // 1 3 5 7 9
}
```

## The goto statement

The `goto` statement transfers execution to a label (denoted with a colon suffix) within a statement block. The following iterates the numbers 1 through 5, mimicking a `for` loop:

```
int i = 1;
startLoop:
if (i <= 5)
{
    Console.Write (i + " "); // 1 2 3 4 5
    i++;
    goto startLoop;
}
```

## The return statement

The `return` statement exits the method and must return an expression of the method's return type if the method is nonvoid:

```
static decimal AsPercentage (decimal d)
{
    decimal p = d * 100m;
    return p; // Return to calling method with value
}
```

A `return` statement can appear anywhere in a method.

# Namespaces

A namespace is a domain within which type names must be unique. Types are typically organized into hierarchical namespaces—both to avoid naming conflicts and to make type names easier to find. For example, the `RSA` type that handles public key encryption is defined within the following namespace:

```
System.Security.Cryptography
```

A namespace forms an integral part of a type's name. The following code calls `RSA`'s `Create` method:

```
System.Security.Cryptography.RSA rsa =
    System.Security.Cryptography.RSA.Create();
```

---

**NOTE**

Namespaces are independent of assemblies, which are units of deployment such as an *.exe* or *.dll*.

Namespaces also have no impact on member accessibility: *public*, *internal*, *private*, and so on.

---

The `namespace` keyword defines a namespace for types within that block. For example:

```
namespace Outer.Middle.Inner
{
    class Class1 {}
    class Class2 {}
}
```

The dots in the namespace indicate a hierarchy of nested namespaces. The code that follows is semantically identical to the preceding example.

```
namespace Outer
{
    namespace Middle
    {
        namespace Inner
        {
            class Class1 {}
            class Class2 {}
        }
    }
}
```

You can refer to a type with its *fully qualified name*, which includes all namespaces from the outermost to the innermost. For example, we could refer to `Class1` in the preceding example as `Outer.Middle.Inner.Class1`.

Types not defined in any namespace are said to reside in the *global namespace*. The global namespace also includes top-level namespaces, such as `Outer` in our example.

## The using Directive

The `using` directive *imports* a namespace and is a convenient way to refer to types without their fully qualified names. For example, we can refer to `Class1` in the preceding example as follows:

```
using Outer.Middle.Inner;

class Test    // Test is in the global namespace
{
    static void Main()
    {
        Class1 c;    // Don't need fully qualified name
        ...
    }
}
```

A `using` directive can be nested within a namespace itself, to limit the scope of the directive.

## Rules Within a Namespace

### Name scoping

Names declared in outer namespaces can be used unqualified within inner namespaces. In this example, the names `Middle` and `Class1` are implicitly imported into `Inner`:

```
namespace Outer
{
    namespace Middle
    {
        class Class1 {}

        namespace Inner
        {
            class Class2 : Class1 {}
        }
    }
}
```

If you want to refer to a type in a different branch of your namespace hierarchy, you can use a partially qualified name.

As you can see in the following example, we base `SalesReport` on `Common.ReportBase`:

```
namespace MyTradingCompany
{
    namespace Common
    {
        class ReportBase {}
    }
    namespace ManagementReporting
    {
        class SalesReport : Common.ReportBase {}
    }
}
```

## Name hiding

If the same type name appears in both an inner and outer namespace, the inner name wins. To refer to the type in the outer namespace, you must qualify its name.

---

### NOTE

All type names are converted to fully qualified names at compile time. Intermediate Language (IL) code contains no unqualified or partially qualified names.

---

## Repeated namespaces

You can repeat a namespace declaration, as long as the type names within the namespaces don't conflict:

```
namespace Outer.Middle.Inner { class Class1 {} }
namespace Outer.Middle.Inner { class Class2 {} }
```

The classes can even span source files and assemblies.

## The `global::` qualifier

Occasionally, a fully qualified type name may conflict with an inner name. You can force C# to use the fully qualified type name by prefixing it with `global::` as follows:

```
global::System.Text.StringBuilder sb;
```



## Aliasing Types and Namespaces

Importing a namespace can result in type-name collision. Rather than importing the whole namespace, you can import just the specific types you need, giving each type an alias. For example:

```
using PropertyInfo2 = System.Reflection.PropertyInfo;
class Program { PropertyInfo2 p; }
```

An entire namespace can be aliased, as follows:

```
using R = System.Reflection;
class Program { R.PropertyInfo p; }
```

## Classes

A class is the most common kind of reference type. The simplest possible class declaration is as follows:

```
class Foo
{
}
```

Optionally, a more complex class has the following:

Preceding the keyword <code>class</code>	<i>Attributes and class modifiers.</i> The non-nested class modifiers are <code>public</code> , <code>internal</code> , <code>abstract</code> , <code>sealed</code> , <code>static</code> , <code>unsafe</code> , and <code>partial</code> .
Following <code>YourClassName</code>	<i>Generic type parameters, a base class, and interfaces.</i>
Within the braces	<i>Class members</i> (these are <i>methods, properties, indexers, events, fields, constructors, operator functions, nested types, and a finalizer</i> ).

## Fields

A *field* is a variable that is a member of a class or struct. For example:

```
class Octopus
{
    string name;
}
```

```
    public int Age = 10;
}
```

A field may have the `readonly` modifier to prevent it from being modified after construction. A read-only field can be assigned only in its declaration or within the enclosing type's constructor.

Field initialization is optional. An uninitialized field has a default value (0, `\0`, `null`, `false`). Field initializers run before constructors, in the order in which they appear.

For convenience, you may declare multiple fields of the same type in a comma-separated list. This is a convenient way for all the fields to share the same attributes and field modifiers. For example:

```
static readonly int legs = 8, eyes = 1;
```

## Methods

A method performs an action in a series of statements. A method can receive *input* data from the caller by specifying *parameters* and *output* data back to the caller by specifying a *return type*. A method can specify a `void` return type, indicating that it doesn't return any value to its caller. A method can also output data back to the caller via `ref/out` parameters.

A method's *signature* must be unique within the type. A method's signature comprises its name and parameter types (but not the parameter *names*, nor the return type).

## Overloading methods

A type may overload methods (have multiple methods with the same name), as long as the parameter types are different. For example, the following methods can all coexist in the same type:

```
void Foo (int x);
void Foo (double x);
void Foo (int x, float y);
void Foo (float x, int y);
```

## Instance Constructors

Constructors run initialization code on a class or struct. A constructor is defined like a method, except the method name and return type are reduced to the name of the enclosing type:

```
public class Panda
{
    string name;           // Define field
    public Panda (string n) // Define constructor
    {
        name = n;         // Initialization code
    }
}
...
Panda p = new Panda ("Petey"); // Call constructor
```

A class or struct may overload constructors. One overload may call another, using the `this` keyword:

```
public class Wine
{
    public Wine (decimal price) {...}

    public Wine (decimal price, int year)
        : this (price) {...}
}
```

When one constructor calls another, the *called constructor* executes first.

You can pass an *expression* into another constructor as follows:

```
public Wine (decimal price, DateTime year)
    : this (price, year.Year) {...}
```

The expression itself cannot make use of the `this` reference, for example, to call an instance method. It can, however, call static methods.

### Implicit parameterless constructors

For classes, the C# compiler automatically generates a parameterless constructor if and only if you do not define any constructors. However, as soon as you define at least one

constructor, the parameterless constructor is no longer automatically generated.

For structs, a parameterless constructor is intrinsic to the struct; therefore, you cannot define your own. The role of a struct's implicit parameterless constructor is to initialize each field with default values.

## Nonpublic constructors

Constructors do not need to be public. A common reason to have a nonpublic constructor is to control instance creation via a static method call. The static method could be used to return an object from a pool rather than creating a new object, or return a specialized subclass chosen based on input arguments.

## Object Initializers

To simplify object initialization, the accessible fields or properties of an object can be initialized in a single statement directly after construction. For example, consider the following class:

```
public class Bunny
{
    public string Name;
    public bool LikesCarrots, LikesHumans;

    public Bunny () {}
    public Bunny (string n) { Name = n; }
}
```

Using object initializers, you can instantiate Bunny objects as follows:

```
Bunny b1 = new Bunny {
    Name="Bo",
    LikesCarrots = true,
    LikesHumans = false
};
```

```
Bunny b2 = new Bunny ("Bo") {
    LikesCarrots = true,
    LikesHumans = false
};
```

## The this Reference

The `this` reference refers to the instance itself. In the following example, the `Marry` method uses `this` to set the `partner`'s `mate` field:

```
public class Panda
{
    public Panda Mate;

    public void Marry (Panda partner)
    {
        Mate = partner;
        partner.Mate = this;
    }
}
```

The `this` reference also disambiguates a local variable or parameter from a field. For example:

```
public class Test
{
    string name;
    public Test (string name) { this.name = name; }
}
```

The `this` reference is valid only within nonstatic members of a class or struct.

## Properties

Properties look like fields from the outside, but internally they contain logic, like methods do. For example, you can't tell by looking at the following code whether `CurrentPrice` is a field or a property:

```
Stock msft = new Stock();
msft.CurrentPrice = 30;
msft.CurrentPrice -= 3;
Console.WriteLine (msft.CurrentPrice);
```

A property is declared like a field, but with a `get/set` block added. Here's how to implement `CurrentPrice` as a property:

```
public class Stock
{
    decimal currentPrice; // The private "backing" field

    public decimal CurrentPrice // The public property
    {
        get { return currentPrice; }
        set { currentPrice = value; }
    }
}
```

`get` and `set` denote property *accessors*. The `get` accessor runs when the property is read. It must return a value of the property's type. The `set` accessor runs when the property is assigned. It has an implicit parameter named `value` of the property's type that you typically assign to a private field (in this case, `currentPrice`).

Although properties are accessed in the same way as fields, they differ in that they give the implementer complete control over getting and setting its value. This control enables the implementer to choose whatever internal representation is needed, without exposing the internal details to the user of the property. In this example, the `set` method could throw an exception if `value` was outside a valid range of values.

---

#### NOTE

Throughout this book, we use public fields to keep the examples free of distraction. In a real application, you would typically favor public properties over public fields to promote encapsulation.

---

A property is read-only if it specifies only a `get` accessor, and it is write-only if it specifies only a `set` accessor. Write-only properties are rarely used. A property typically has a dedicated backing field to store the underlying data. However, it need not—it may instead return a value computed from other data.

## Automatic properties

The most common implementation for a property is a getter and/or setter that simply reads and writes to a private field of the same type as the property. An *automatic property* declaration instructs the compiler to provide this implementation. We can redeclare the first example in this section as follows:

```
public class Stock
{
    public decimal CurrentPrice { get; set; }
}
```

The compiler automatically generates a private backing field of a compiler-generated name that cannot be referred to. The `set` accessor can be marked `private` if you want to expose the property as read-only to other types.

## get and set accessibility

The `get` and `set` accessors can have different access levels. The typical use case for this is to have a `public` property with an `internal` or `private` access modifier on the setter:

```
private decimal x;
public decimal X
{
    get { return x; }
    private set { x = Math.Round (value, 2); }
}
```

Notice that you declare the property itself with the more permissive access level (`public`, in this case), and add the modifier to the accessor you want to be *less* accessible.

## Indexers

Indexers provide a natural syntax for accessing elements in a class or struct that encapsulate a list or dictionary of values. Indexers are similar to properties, but are accessed via an index argument rather than a property name. The `string` class has an indexer that lets you access each of its `char` values via an `int` index:

```
string s = "hello";
Console.WriteLine (s[0]); // 'h'
Console.WriteLine (s[3]); // 'l'
```

The syntax for using indexers is like that for using arrays when the index is an integer type.

## Implementing an indexer

To write an indexer, define a property called `this`, specifying the arguments in square brackets. For instance:

```
class Sentence
{
    string[] words = "The quick brown fox".Split();

    public string this [int wordNum]    // indexer
    {
        get { return words [wordNum]; }
        set { words [wordNum] = value; }
    }
}
```

Here's how we could use this indexer:

```
Sentence s = new Sentence();
Console.WriteLine (s[3]);    // fox
s[3] = "kangaroo";
Console.WriteLine (s[3]);    // kangaroo
```

A type may declare multiple indexers, each with parameters of different types. An indexer can also take more than one parameter:

```
public string this [int arg1, string arg2]
{
    get { ... } set { ... }
}
```

If you omit the set accessor, an indexer becomes read-only.

## Constants

A *constant* is a field whose value can never change. A constant is evaluated statically at compile time and the compiler literally substitutes its value whenever used, rather like a macro in



C++. A constant can be any of the built-in numeric types, `bool`, `char`, `string`, or an enum type.

A constant is declared with the `const` keyword and must be initialized with a value. For example:

```
public class Test
{
    public const string Message = "Hello World";
}
```

A constant is much more restrictive than a `static readonly` field—both in the types you can use and in field initialization semantics. A constant also differs from a `static readonly` field in that the evaluation of the constant occurs at compile time. Constants can also be declared local to a method:

```
static void Main()
{
    const double twoPI = 2 * System.Math.PI;
    ...
}
```

## Static Constructors

A static constructor executes once per *type*, rather than once per *instance*. A type can define only one static constructor, and it must be parameterless and have the same name as the type:

```
class Test
{
    static Test() { Console.Write ("Type Initialized"); }
}
```

The runtime automatically invokes a static constructor just prior to the type being used. Two things trigger this: instantiating the type, and accessing a static member in the type.

---

### WARNING

If a static constructor throws an unhandled exception, that type becomes *unusable* for the life of the application.

---

Static field initializers run just *before* the static constructor is called. If a type has no static constructor, field initializers will execute just prior to the type being used—or *anytime earlier* at the whim of the runtime. (This means that the presence of a static constructor may cause field initializers to execute later in the program than they would otherwise.)

## Static Classes

A class can be marked `static`, indicating that it must be composed solely of static members and cannot be subclassed. The `System.Console` and `System.Math` classes are good examples of static classes.

## Finalizers

Finalizers are class-only methods that execute before the garbage collector reclaims the memory for an unreferenced object. The syntax for a finalizer is the name of the class prefixed with the `~` symbol:

```
class Class1
{
    ~Class1() { ... }
}
```

C# translates a finalizer into a method that overrides the `Finalize` method in the `object` class. We discuss garbage collection and finalizers fully in Chapter 12 of *C# 4.0 in a Nutshell* (O'Reilly).

## Partial Types and Methods

Partial types allow a type definition to be split—typically across multiple files. A common scenario is for a partial class to be auto-generated from some other source (e.g., an XSD), and for that class to be augmented with additional hand-authored methods. For example:

```
// PaymentFormGen.cs - auto-generated
partial class PaymentForm { ... }
```

```
// PaymentForm.cs - hand-authored
partial class PaymentForm { ... }
```

Each participant must have the `partial` declaration.

Participants cannot have conflicting members. A constructor with the same parameters, for instance, cannot be repeated. Partial types are resolved entirely by the compiler, which means that each participant must be available at compile time and must reside in the same assembly.

A base class may be specified on a single participant or on all participants. In addition, each participant can independently specify interfaces to implement. We cover base classes and interfaces in the sections [“Inheritance” on page 70](#) and [“Interfaces” on page 85](#).

## Partial methods

A partial type may contain *partial methods*. These let an auto-generated partial type provide customizable hooks for manual authoring. For example:

```
partial class PaymentForm // In auto-generated file
{
    partial void ValidatePayment (decimal amount);
}

partial class PaymentForm // In hand-authored file
{
    partial void ValidatePayment (decimal amount)
    {
        if (amount > 100) Console.Write ("Expensive!");
    }
}
```

A partial method consists of two parts: a *definition* and an *implementation*. The definition is typically written by a code generator, and the implementation is typically manually authored. If an implementation is not provided, the definition of the partial method is compiled away. This allows auto-generated code to be liberal in providing hooks, without having

to worry about code bloat. Partial methods must be `void` and are implicitly `private`.

## Inheritance

A class can *inherit* from another class to extend or customize the original class. Inheriting from a class lets you reuse the functionality in that class instead of building it from scratch. A class can inherit from only a single class, but can itself be inherited by many classes, thus forming a class hierarchy. In this example, we start by defining a class called `Asset`:

```
public class Asset { public string Name; }
```

Next, we define classes called `Stock` and `House`, which will inherit from `Asset`. `Stock` and `House` get everything an `Asset` has, plus any additional members that they define:

```
public class Stock : Asset // inherits from Asset
{
    public long SharesOwned;
}

public class House : Asset // inherits from Asset
{
    public decimal Mortgage;
}
```

Here's how we can use these classes:

```
Stock msft = new Stock { Name="MSFT",
                        SharesOwned=1000 };

Console.WriteLine (msft.Name);           // MSFT
Console.WriteLine (msft.SharesOwned);    // 1000

House mansion = new House { Name="Mansion",
                            Mortgage=250000 };

Console.WriteLine (mansion.Name);        // Mansion
Console.WriteLine (mansion.Mortgage);    // 250000
```

The *subclasses*, `Stock` and `House`, inherit the `Name` property from the *base class*, `Asset`.

Subclasses are also called *derived classes*.

## Polymorphism

References are polymorphic. This means a variable of type *x* can refer to an object that subclasses *x*. For instance, consider the following method:

```
public static void Display (Asset asset)
{
    System.Console.WriteLine (asset.Name);
}
```

This method can display both a **Stock** and a **House**, since they are both **Assets**. Polymorphism works on the basis that subclasses (**Stock** and **House**) have all the features of their base class (**Asset**). The converse, however, is not true. If **Display** was rewritten to accept a **House**, you could not pass in an **Asset**.

## Casting and Reference Conversions

An object reference can be:

- Implicitly *upcast* to a base class reference
- Explicitly *downcast* to a subclass reference

Upcasting and downcasting between compatible reference types performs *reference conversions*: a new reference is created that points to the *same* object. An upcast always succeeds; a downcast succeeds only if the object is suitably typed.

### Upcasting

An upcast operation creates a base class reference from a subclass reference. For example:

```
Stock msft = new Stock();    // From previous example
Asset a = msft;             // Upcast
```

After the upcast, variable **a** still references the same **Stock** object as variable **msft**. The object being referenced is not itself altered or converted:

```
Console.WriteLine (a == msft);           // True
```

Although `a` and `msft` refer to the identical object, `a` has a more restrictive view on that object:

```
Console.WriteLine (a.Name);             // OK
Console.WriteLine (a.SharesOwned);     // Error
```

The last line generates a compile-time error because the variable `a` is of type `Asset`, even though it refers to an object of type `Stock`. To get to its `SharesOwned` field, you must *downcast* the `Asset` to a `Stock`.

## Downcasting

A downcast operation creates a subclass reference from a base class reference. For example:

```
Stock msft = new Stock();
Asset a = msft;                               // Upcast
Stock s = (Stock)a;                          // Downcast
Console.WriteLine (s.SharesOwned);           // <No error>
Console.WriteLine (s == a);                  // True
Console.WriteLine (s == msft);               // True
```

As with an upcast, only references are affected—not the underlying object. A downcast requires an explicit cast because it can potentially fail at runtime:

```
House h = new House();
Asset a = h;           // Upcast always succeeds
Stock s = (Stock)a;   // Downcast fails: a is not a Stock
```

If a downcast fails, an `InvalidCastException` is thrown. This is an example of *runtime type checking* (see [“Static and Runtime Type Checking”](#) on page 80).

## The `as` operator

The `as` operator performs a downcast that evaluates to `null` (rather than throwing an exception) if the downcast fails:

```
Asset a = new Asset();
Stock s = a as Stock; // s is null; no exception thrown
```

This is useful when you’re going to subsequently test whether the result is `null`:

```
if (s != null) Console.WriteLine (s.SharesOwned);
```

The `as` operator cannot perform *custom conversions* (see “[Operator Overloading](#)” on page 135) and it cannot do numeric conversions.

## The `is` operator

The `is` operator tests whether a reference conversion would succeed; in other words, whether an object derives from a specified class (or implements an interface). It is often used to test before downcasting:

```
if (a is Stock) Console.Write (((Stock)a).SharesOwned);
```

The `is` operator does not consider custom or numeric conversions, but it does consider *unboxing conversions* (see “[The object Type](#)” on page 78).

## Virtual Function Members

A function marked as `virtual` can be *overridden* by subclasses wanting to provide a specialized implementation. Methods, properties, indexers, and events can all be declared `virtual`:

```
public class Asset
{
    public string Name;
    public virtual decimal Liability { get { return 0; } }
}
```

A subclass overrides a virtual method by applying the `override` modifier:

```
public class House : Asset
{
    public decimal Mortgage;

    public override decimal Liability
        { get { return Mortgage; } }
}
```

By default, the `Liability` of an `Asset` is 0. A `Stock` does not need to specialize this behavior. However, the `House` specializes the `Liability` property to return the value of the `Mortgage`:

```

House mansion = new House { Name="Mansion",
                             Mortgage=250000 };
Asset a = mansion;
Console.WriteLine (mansion.Liability); // 250000
Console.WriteLine (a.Liability);      // 250000

```

The signatures, return types, and accessibility of the virtual and overridden methods must be identical. An overridden method can call its base class implementation via the `base` keyword (see “The base Keyword” on page 75).

## Abstract Classes and Abstract Members

A class declared as *abstract* can never be instantiated. Instead, only its concrete *subclasses* can be instantiated.

Abstract classes are able to define *abstract members*. Abstract members are like virtual members, except they don’t provide a default implementation. That implementation must be provided by the subclass, unless that subclass is also declared *abstract*:

```

public abstract class Asset
{
    // Note empty implementation
    public abstract decimal NetValue { get; }
}

```

Subclasses override abstract members just as though they were virtual.

## Hiding Inherited Members

A base class and a subclass may define identical members. For example:

```

public class A      { public int Counter = 1; }
public class B : A { public int Counter = 2; }

```

The `Counter` field in class `B` is said to *hide* the `Counter` field in class `A`. Usually, this happens by accident, when a member is added to the base type *after* an identical member was added to the subtype. For this reason, the compiler generates a warning, and then resolves the ambiguity as follows:



- References to A (at compile time) bind to A.Counter.
- References to B (at compile time) bind to B.Counter.

Occasionally, you want to hide a member deliberately, in which case you can apply the `new` modifier to the member in the subclass. The `new` modifier *does nothing more than suppress the compiler warning that would otherwise result*:

```
public class A    { public    int Counter = 1; }
public class B : A { public new int Counter = 2; }
```

The `new` modifier communicates your intent to the compiler—and other programmers—that the duplicate member is not an accident.

## Sealing Functions and Classes

An overridden function member may *seal* its implementation with the `sealed` keyword to prevent it from being overridden by further subclasses. In our earlier virtual function member example, we could have sealed `House`'s implementation of `Liability`, preventing a class that derives from `House` from overriding `Liability`, as follows:

```
public sealed override decimal Liability { get { ... } }
```

You can also seal the class itself, implicitly sealing all the virtual functions, by applying the `sealed` modifier to the class itself.

## The base Keyword

The `base` keyword is similar to the `this` keyword. It serves two essential purposes: accessing an overridden function member from the subclass, and calling a base class constructor (see next section).

In this example, `House` uses the `base` keyword to access `Asset`'s implementation of `Liability`:

```
public class House : Asset
{
    ...
}
```

```

public override decimal Liability
{
    get { return base.Liability + Mortgage; }
}

```

With the **base** keyword, we access *Asset*'s *Liability* property *nonvirtually*. This means we will always access *Asset*'s version of this property—regardless of the instance's actual runtime type.

The same approach works if *Liability* is *hidden* rather than *overridden*. (You can also access hidden members by casting to the base class before invoking the function.)

## Constructors and Inheritance

A subclass must declare its own constructors. For example, if we define *Baseclass* and *Subclass* as follows:

```

public class Baseclass
{
    public int X;
    public Baseclass () { }
    public Baseclass (int x) { this.X = x; }
}
public class Subclass : Baseclass { }

```

the following is illegal:

```
Subclass s = new Subclass (123);
```

*Subclass* must “redefine” any constructors it wants to expose. In doing so, it can call any of the base class's constructors with the **base** keyword:

```

public class Subclass : Baseclass
{
    public Subclass (int x) : base (x) { ... }
}

```

The **base** keyword works rather like the **this** keyword, except that it calls a constructor in the base class. Base class constructors always execute first; this ensures that *base* initialization occurs before *specialized* initialization.

If a constructor in a subclass omits the **base** keyword, the base type's *parameterless* constructor is implicitly called (if the base class has no parameterless constructor, the compiler generates an error).

## Constructor and field initialization order

When an object is instantiated, initialization takes place in the following order:

1. From subclass to base class:
  - a. Fields are initialized.
  - b. Arguments to base-class constructor calls are evaluated.
2. From base class to subclass:
  - a. Constructor bodies execute.

## Overloading and Resolution

Inheritance has an interesting impact on method overloading. Consider the following two overloads:

```
static void Foo (Asset a) { }
static void Foo (House h) { }
```

When an overload is called, the most specific type has precedence:

```
House h = new House (...);
Foo(h); // Calls Foo(House)
```

The particular overload to call is determined statically (at compile time) rather than at runtime. The following code calls `Foo(Asset)`, even though the runtime type of `a` is `House`:

```
Asset a = new House (...);
Foo(a); // Calls Foo(Asset)
```

---

**NOTE**

If you cast `Asset` to `dynamic` (see “[Dynamic Binding \(C# 4.0\)](#)” on page 165), the decision as to which overload to call is deferred until runtime and is based on the object’s actual type.

---

## The object Type

`object` (`System.Object`) is the ultimate base class for all types. Any type can be implicitly upcast to `object`.

To illustrate how this is useful, consider a general-purpose *stack*. A stack is a data structure based on the principle of LIFO—“Last In, First Out.” A stack has two operations: *push* an object on the stack, and *pop* an object off the stack. Here is a simple implementation that can hold up to 10 objects:

```
public class Stack
{
    int position;
    object[] data = new object[10];
    public void Push (object o) { data[position++] = o; }
    public object Pop() { return data[--position]; }
}
```

Because `Stack` works with the `object` type, we can `Push` and `Pop` instances of *any type* to and from the `Stack`:

```
Stack stack = new Stack();
stack.Push ("sausage");
string s = (string) stack.Pop(); // Downcast
Console.WriteLine (s);         // sausage
```

`object` is a reference type, by virtue of being a class. Despite this, value types, such as `int`, can also be cast to and from `object`. To make this possible, the CLR must perform some special work to bridge the underlying differences between value and reference types. This process is called *boxing* and *unboxing*.

---

**NOTE**

In “Generics” on page 92, we’ll describe how to improve our Stack class to better handle stacks with same-typed elements.

---

## Boxing and Unboxing

Boxing is the act of casting a value-type instance to a reference-type instance. The reference type may be either the `object` class or an interface (see “Interfaces” on page 85). In this example, we box an `int` into an object:

```
int x = 9;
object obj = x;           // Box the int
```

Unboxing reverses the operation, by casting the object back to the original value type:

```
int y = (int)obj;        // Unbox the int
```

Unboxing requires an explicit cast. The runtime checks that the stated value type matches the actual object type, and throws an `InvalidCastException` if the check fails. For instance, the following throws an exception, because `long` does not exactly match `int`:

```
object obj = 9;          // 9 is inferred to be of type int
long x = (long) obj;    // InvalidCastException
```

The following succeeds, however:

```
object obj = 9;
long x = (int) obj;
```

As does this:

```
object obj = 3.5;       // 3.5 inferred to be type double
int x = (int) (double) obj; // x is now 3
```

In the last example, `(double)` performs an *unboxing* and then `(int)` performs a *numeric conversion*.

Unlike with reference conversions, boxing *copies* the value-type instance into the new object, and unboxing *copies* the contents of the object back into a value-type instance:

```
int i = 3;
object boxed = i;
i = 5;
Console.WriteLine (boxed);    // 3
```

## Static and Runtime Type Checking

C# checks types both statically (at compile time) and at runtime.

Static type checking enables the compiler to verify the correctness of your program without running it. The following code will fail because the compiler enforces static typing:

```
int x = "5";
```

Runtime type checking is performed by the CLR when you downcast via a reference conversion or unboxing:

```
object y = "5";
int z = (int) y;    // Runtime error, downcast failed
```

Runtime type checking is possible because each object on the heap internally stores a little type token. This token can be retrieved by calling the `GetType` method of `object`.

## The `GetType` Method and `typeof` Operator

All types in C# are represented at runtime with an instance of `System.Type`. There are two basic ways to get a `System.Type` object: call `GetType` on the instance, or use the `typeof` operator on a type name. `GetType` is evaluated at runtime; `typeof` is evaluated statically at compile time.

`System.Type` has properties for such things as the type's name, assembly, base type, and so on. For example:

Download from Library of Wow! eBook  
<[www.wowebook.com](http://www.wowebook.com)>

```
int x = 3;

Console.Write (x.GetType().Name);           // Int32
Console.Write (typeof(int).Name);          // Int32
Console.Write (x.GetType().FullName);      // System.Int32
Console.Write (x.GetType() == typeof(int)); // True
```

`System.Type` also has methods that act as a gateway to the runtime's reflection model. For detailed information, see Chapter 18 of *C# 4.0 in a Nutshell* (O'Reilly).

## Object Member Listing

Here are all the members of `object`:

```
public extern Type GetType();
public virtual bool Equals (object obj);
public static bool Equals (object objA, object objB);
public static bool ReferenceEquals (object objA,
                                   object objB);

public virtual int GetHashCode();
public virtual string ToString();
protected override void Finalize();
protected extern object MemberwiseClone();
```

## Equals, ReferenceEquals, and GetHashCode

The `Equals` method in the `object` class is similar to the `==` operator, except that `Equals` is virtual, whereas `==` is static. The following example illustrates the difference:

```
object x = 3;
object y = 3;
Console.WriteLine (x == y);           // False
Console.WriteLine (x.Equals (y));     // True
```

Because `x` and `y` have been cast to the `object` type, the compiler statically binds to `object`'s `==` operator, which uses *reference-type* semantics to compare two instances. (And because `x` and `y` are boxed, they are represented in separate memory locations, and so are unequal.) The virtual `Equals` method, however, defers to the `Int32` type's `Equals` method, which uses *value-type* semantics in comparing two values.

The static `object.Equals` method simply calls the virtual `Equals` method on the first argument—after checking that the arguments are not null:

```
object x = null, y = 3;
bool error = x.Equals(y); // Runtime error!
bool ok = object.Equals(x, y); // OK (false)
```

`ReferenceEquals` forces a reference-type equality comparison (this is occasionally useful on reference types where the `==` operator has been overloaded to do otherwise).

`GetHashCode` emits a hash code suitable for use with hashtable-based dictionaries, namely `System.Collections.Generic.Dictionary` and `System.Collections.Hashtable`.

To customize a type's equality semantics, you must at a minimum override `Equals` and `GetHashCode`. You would also usually overload the `==` and `!=` operators. For an example on how to do both, see [“Operator Overloading” on page 135](#).

## The ToString Method

The `ToString` method returns the default textual representation of a type instance. The `ToString` method is overridden by all built-in types:

```
string s1 = 1.ToString(); // s1 is "1"
string s2 = true.ToString(); // s2 is "True"
```

You can override the `ToString` method on custom types as follows:

```
public override string ToString() { return "Foo"; }
```

## Structs

A *struct* is similar to a class, with the following key differences:

- A struct is a value type, whereas a class is a reference type.
- A struct does not support inheritance (other than implicitly deriving from `object`, or more precisely, `System.ValueType`).



A struct can have all the members a class can, except a parameterless constructor, a finalizer, and virtual members.

A struct is used instead of a class when value-type semantics are desirable. Good examples are numeric types, where it is more natural for assignment to copy a value rather than a reference. Because a struct is a value type, each instance does not require instantiation of an object on the heap; this can result in a useful saving when creating many instances of a type. For instance, creating an array of value types requires only a single heap allocation.

## Struct Construction Semantics

The construction semantics of a struct are as follows:

- A parameterless constructor that you can't override implicitly exists. This performs a bitwise-zeroing of its fields.
- When you define a struct constructor (with parameters), you must explicitly assign every field.
- You can't have field initializers in a struct.

## Access Modifiers

To promote encapsulation, a type or type member may limit its *accessibility* to other types and other assemblies by adding one of five *access modifiers* to the declaration:

### **public**

Fully accessible. This is the implicit accessibility for members of an enum or interface.

### **internal**

Accessible only within containing assembly or friend assemblies. This is default accessibility for non-nested types.

### **private**

Visible only within containing type. This is the default accessibility for members of a class or struct.

**protected**

Visible only within containing type or subclasses.

**protected internal**

The *union* of **protected** and **internal** accessibility (this is *less* restrictive than **protected** or **internal** alone).

In the following example, **Class2** is accessible from outside its assembly; **Class1** is not:

```
class Class1 {           // Class1 is internal (default)
    public class Class2 {}
}
```

**ClassB** exposes field **x** to other types in the same assembly; **ClassA** does not:

```
class ClassA { int x;    } // x is private
class ClassB { internal int x; }
```

When overriding a base class function, accessibility must be identical on the overridden function. The compiler prevents any inconsistent use of access modifiers—for example, a subclass itself can be less accessible than a base class, but not more.

## Friend Assemblies

In advanced scenarios, you can expose **internal** members to other *friend* assemblies by adding the `System.Runtime.CompilerServices.InternalsVisibleTo` assembly attribute, specifying the name of the friend assembly as follows:

```
[assembly: InternalsVisibleTo ("Friend")]
```

If the friend assembly is signed with a strong name, you must specify its *full* 160-byte public key. You can extract this key via a LINQ query—an interactive example is given in LINQPad’s free sample library for *C# 4.0 in a Nutshell* (O’Reilly).

## Accessibility Capping

A type caps the accessibility of its declared members. The most common example of capping is when you have an **internal** type with **public** members. For example:

```
class C { public void Foo() {} }
```

C's (default) internal accessibility caps `Foo`'s accessibility, effectively making `Foo` `internal`. A common reason `Foo` would be marked `public` is to make for easier refactoring, should C later be changed to `public`.

## Interfaces

An interface is similar to a class, but it provides a specification rather than an implementation for its members. An interface is special in the following ways:

- A class can implement *multiple* interfaces. In contrast, a class can inherit from only a *single* class.
- Interface members are *all implicitly abstract*. In contrast, a class can provide both abstract members and concrete members with implementations.
- *Structs* can implement interfaces, whereas a struct cannot inherit from a class.

An interface declaration is like a class declaration, but it provides no implementation for its members, since all its members are implicitly abstract. These members will be implemented by the classes and structs that implement the interface. An interface can contain only methods, properties, events, and indexers, which not coincidentally, are precisely the members of a class that can be abstract.

Here is a slightly simplified version of the `IEnumerator` interface, defined in `System.Collections`:

```
public interface IEnumerator
{
    bool MoveNext();
    object Current { get; }
}
```

Interface members are always implicitly public and cannot declare an access modifier. Implementing an interface means providing a `public` implementation for all its members:

```

internal class Countdown : IEnumerator
{
    int count = 11;
    public bool MoveNext() { return count-- > 0 ; }
    public object Current { get { return count; } }
}

```

You can implicitly cast an object to any interface that it implements:

```

IEnumerator e = new Countdown();
while (e.MoveNext())
    Console.Write (e.Current);    // 109876543210

```

## Extending an Interface

Interfaces may derive from other interfaces. For instance:

```

public interface IUndoable          { void Undo(); }
public interface IRedoable : IUndoable { void Redo(); }

```

IRedoable inherits all the members of IUndoable.

## Explicit Interface Implementation

Implementing multiple interfaces can sometimes result in a collision between member signatures. You can resolve such collisions by *explicitly implementing* an interface member. For example:

```

interface I1 { void Foo(); }
interface I2 { int Foo(); }

public class Widget : I1, I2
{
    public void Foo()    // Implicit implementation
    {
        Console.Write ("Widget's implementation of I1.Foo");
    }

    int I2.Foo()    // Explicit implementation of I2.Foo
    {
        Console.Write ("Widget's implementation of I2.Foo");
        return 42;
    }
}

```

Because both `I1` and `I2` have conflicting `Foo` signatures, `Widget` explicitly implements `I2`'s `Foo` method. This lets the two methods coexist in one class. The only way to call an explicitly implemented member is to cast to its interface:

```
Widget w = new Widget();
w.Foo();           // Widget's implementation of I1.Foo
((I1)w).Foo();    // Widget's implementation of I1.Foo
((I2)w).Foo();    // Widget's implementation of I2.Foo
```

Another reason to explicitly implement interface members is to hide members that are highly specialized and distracting to a type's normal use case. For example, a type that implements `ISerializable` would typically want to avoid flaunting its `ISerializable` members unless explicitly cast to that interface.

## Implementing Interface Members Virtually

An implicitly implemented interface member is, by default, sealed. It must be marked `virtual` or `abstract` in the base class in order to be overridden: calling the interface member through either the base class or the interface then calls the subclass's implementation.

An explicitly implemented interface member cannot be marked `virtual`, nor can it be overridden in the usual manner. It can, however, be *reimplemented*.

## Reimplementing an Interface in a Subclass

A subclass can *reimplement* any interface member already implemented by a base class. Reimplementation hijacks a member implementation (when called through the interface) and works whether or not the member is `virtual` in the base class.

In the following example, `TextBox` implements `IUndo.Undo` explicitly, and so it cannot be marked as `virtual`. In order to “override” it, `RichTextBox` must reimplement `IUndo`'s `Undo` method:

```

public interface IUndoable { void Undo(); }

public class TextBox : IUndoable
{
    void IUndoable.Undo()
    { Console.WriteLine ("TextBox.Undo"); }
}

public class RichTextBox : TextBox, IUndoable
{
    public new void Undo()
    { Console.WriteLine ("RichTextBox.Undo"); }
}

```

Calling the reimplemented member through the interface calls the subclass's implementation:

```

RichTextBox r = new RichTextBox();
r.Undo();           // RichTextBox.Undo
((IUndoable)r).Undo(); // RichTextBox.Undo

```

In this case, `Undo` is implemented explicitly. Implicitly implemented members can also be reimplemented, but the effect is nonpervasive, in that calling the member through the base class invokes the base implementation.

## Enums

An enum is a special value type that lets you specify a group of named numeric constants. For example:

```

public enum BorderSide { Left, Right, Top, Bottom }

```

We can use this enum type as follows:

```

BorderSide topSide = BorderSide.Top;
bool isTop = (topSide == BorderSide.Top); // true

```

Each enum member has an underlying integral value. By default, the underlying values are of type `int`, and the enum members are assigned the constants `0`, `1`, `2`... (in their declaration order). You may specify an alternative integral type, as follows:

```

public enum BorderSide : byte { Left, Right, Top, Bottom }

```

You may also specify an explicit integral value for each member:

```
public enum BorderSide : byte
{ Left=1, Right=2, Top=10, Bottom=11 }
```

The compiler also lets you explicitly assign *some* of the enum members. The unassigned enum members keep incrementing from the last explicit value. The preceding example is equivalent to:

```
public enum BorderSide : byte
{ Left=1, Right, Top=10, Bottom }
```

## Enum Conversions

You can convert an enum instance to and from its underlying integral value with an explicit cast:

```
int i = (int) BorderSide.Left;
BorderSide side = (BorderSide) i;
bool leftOrRight = (int) side <= 2;
```

You can also explicitly cast one enum type to another; the translation then uses the members' underlying integral values.

The numeric literal `0` is treated specially in that it does not require an explicit cast:

```
BorderSide b = 0; // No cast required
if (b == 0) ...
```

In this particular example, `BorderSide` has no member with an integral value of `0`. This does not generate an error: a limitation of enums is that the compiler and CLR do not prevent the assignment of integrals whose values fall outside the range of members:

```
BorderSide b = (BorderSide) 12345;
Console.WriteLine (b); // 12345
```

## Flags Enums

You can combine enum members. To prevent ambiguities, members of a combinable enum require explicitly assigned values, typically in powers of two. For example:

```
[Flags]
public enum BorderSides
{ Left=1, Right=2, Top=4, Bottom=8 }
```

By convention, a combinable enum type is given a plural rather than singular name. To work with combined enum values, you use bitwise operators, such as `|` and `&`. These operate on the underlying integral values:

```
BorderSides leftRight =
    BorderSides.Left | BorderSides.Right;

if ((leftRight & BorderSides.Left) != 0)
    Console.WriteLine ("Includes Left"); // Includes Left

string formatted = leftRight.ToString(); // "Left, Right"

BorderSides s = BorderSides.Left;
s |= BorderSides.Right;
Console.WriteLine (s == leftRight); // True
```

The `Flags` attribute should be applied to combinable enum types; if you fail to do this, calling `ToString` on an enum instance emits a number rather than a series of names.

For convenience, you can include combination members within an enum declaration itself:

```
[Flags] public enum BorderSides
{
    Left=1, Right=2, Top=4, Bottom=8,
    LeftRight = Left | Right,
    TopBottom = Top | Bottom,
    All       = LeftRight | TopBottom
}
```



## Enum Operators

The operators that work with enums are:

```
=  ==  !=  <  >  <=  >=  +  -  ^  &  |  ~
+=  -=  ++  -  sizeof
```

The bitwise, arithmetic, and comparison operators return the result of processing the underlying integral values. Addition is permitted between an enum and an integral type, but not between two enums.

## Nested Types

A *nested type* is declared within the scope of another type. For example:

```
public class TopLevel
{
    public class Nested { }           // Nested class
    public enum Color { Red, Blue, Tan } // Nested enum
}
```

A nested type has the following features:

- It can access the enclosing type's private members and everything else the enclosing type can access.
- It can be declared with the full range of access modifiers, rather than just `public` and `internal`.
- The default visibility for a nested type is `private` rather than `internal`.
- Accessing a nested type from outside the enclosing type requires qualification with the enclosing type's name (like when accessing static members).

For example, to access `Color.Red` from outside our `TopLevel` class, we'd have to do this:

```
TopLevel.Color color = TopLevel.Color.Red;
```

All types can be nested; however, only classes and structs can *nest*.

# Generics

C# has two separate mechanisms for writing code that is reusable across different types: *inheritance* and *generics*. Whereas inheritance expresses reusability with a base type, generics express reusability with a “template” that contains “placeholder” types. Generics, when compared to inheritance, can *increase type safety* and *reduce casting and boxing*.

## Generic Types

A generic type declares *type parameters*—placeholder types to be filled in by the consumer of the generic type, which supplies the *type arguments*. Here is a generic type, `Stack<T>`, designed to stack instances of type `T`. `Stack<T>` declares a single type parameter `T`:

```
public class Stack<T>
{
    int position;
    T[] data = new T[100];
    public void Push (T obj) { data[position++] = obj; }
    public T Pop()          { return data[--position]; }
}
```

We can use `Stack<T>` as follows:

```
Stack<int> stack = new Stack<int>();
stack.Push(5);
stack.Push(10);
int x = stack.Pop();          // x is 10
int y = stack.Pop();          // y is 5
```

---

### NOTE

Notice that no downcasts are required in the last two lines, avoiding the possibility of runtime error and eliminating the overhead of boxing/unboxing. This makes our generic stack superior to a nongeneric stack that uses `object` in place of `T` (see “[The object Type](#)” on page 78 for an example).

---

`Stack<int>` fills in the type parameter `T` with the type argument `int`, implicitly creating a type on the fly (the synthesis occurs at runtime). `Stack<int>` effectively has the following definition (substitutions appear in bold, with the class name hashed out to avoid confusion):

```
public class ###
{
    int position;
    int[] data;
    public void Push (int obj) { data[position++] = obj; }
    public int Pop()          { return data[--position]; }
}
```

Technically, we say that `Stack<T>` is an *open type*, whereas `Stack<int>` is a *closed type*. At runtime, all generic type instances are closed—with the placeholder types filled in.

## Generic Methods

A generic method declares type parameters within the signature of a method. With generic methods, many fundamental algorithms can be implemented in a general-purpose way only. Here is a generic method that swaps two values of any type:

```
static void Swap<T> (ref T a, ref T b)
{
    T temp = a; a = b; b = temp;
}
```

`Swap<T>` can be used as follows:

```
int x = 5, y = 10;
Swap (ref x, ref y);
```

Generally, there is no need to supply type arguments to a generic method, because the compiler can implicitly infer the type. If there is ambiguity, generic methods can be called with the type arguments as follows:

```
Swap<int> (ref x, ref y);
```

Within a generic *type*, a method is not classed as generic unless it *introduces* type parameters (with the angle bracket syntax). The `Pop` method in our generic stack merely consumes the

type's existing type parameter, T, and is not classed as a generic method.

Methods and types are the only constructs that can introduce type parameters. Properties, indexers, events, fields, constructors, operators, and so on cannot declare type parameters, although they can partake in any type parameters already declared by their enclosing type. In our generic stack example, for instance, we could write an indexer that returns a generic item:

```
public T this [int index] { get { return data[index]; } }
```

Similarly, constructors can partake in existing type parameters, but not *introduce* them.

## Declaring Type Parameters

Type parameters can be introduced in the declaration of classes, structs, interfaces, delegates (see the section “[Delegates](#)” on page 100), and methods. A generic type or method can have multiple parameters:

```
class Dictionary<TKey, TValue> { ... }
```

To instantiate:

```
var myDic = new Dictionary<int,string>();
```

Generic type names and method names can be overloaded as long as the number of type parameters differs. For example, the following two type names do not conflict:

```
class A<T> {}
class A<T1,T2> {}
```

---

### NOTE

By convention, generic types and methods with a *single* type parameter name their parameter T, as long as the intent of the parameter is clear. With *multiple* type parameters, each parameter has a more descriptive name (prefixed by T).

---

## typeof and Unbound Generic Types

Open generic types do not exist at runtime: open generic types are closed as part of compilation. However, it is possible for an *unbound* generic type to exist at runtime—purely as a `Type` object. The only way to specify an unbound generic type in C# is with the `typeof` operator:

```
class A<T> {}
class A<T1,T2> {}
...

Type a1 = typeof (A<>); // Unbound type
Type a2 = typeof (A<,>); // Indicates 2 type args
Console.Write (a2.GetGenericArguments().Count()); // 2
```

You can also use the `typeof` operator to specify a closed type:

```
Type a3 = typeof (A<int,int>);
```

or an open type (which is closed at runtime):

```
class B<T> { void X() { Type t = typeof (T); } }
```

## The default Generic Value

The `default` keyword can be used to get the default value given a generic type parameter. The default value for a reference type is `null`, and the default value for a value type is the result of bitwise-zeroing the type's fields:

```
static void Zap<T> (T[] array)
{
    for (int i = 0; i < array.Length; i++)
        array[i] = default(T);
}
```

## Generic Constraints

By default, a type parameter can be substituted with any type whatsoever. *Constraints* can be applied to a type parameter to require more specific type arguments. There are six kinds of constraint:

```

where T : base-class // Base class constraint
where T : interface // Interface constraint
where T : class // Reference-type constraint
where T : struct // Value-type constraint
where T : new() // Parameterless constructor
// constraint
where U : T // Naked type constraint

```

In the following example, `GenericClass<T,U>` requires `T` to derive from `SomeClass` and implement `Interface1`, and requires `U` to provide a parameterless constructor:

```

class SomeClass {}
interface Interface1 {}

class GenericClass<T,U> where T : SomeClass, Interface1
    where U : new()
{ ... }

```

Constraints can be applied wherever type parameters are defined, whether in methods or type definitions.

A *base class constraint* specifies that the type parameter must subclass (or match) a particular class; an *interface constraint* specifies that the type parameter must implement that interface. These constraints allow instances of the type parameter to be implicitly converted to that class or interface.

The *class constraint* and *struct constraint* specify that `T` must be a reference type or a (non-nullable) value type, respectively. The *parameterless constructor constraint* requires `T` to have a public parameterless constructor and allows you to call `new()` on `T`:

```

static void Initialize<T> (T[] array) where T : new()
{
    for (int i = 0; i < array.Length; i++)
        array[i] = new T();
}

```

The *naked type constraint* requires one type parameter to derive from (or match) another type parameter.

## Subclassing Generic Types

A generic class can be subclassed just like a nongeneric class. The subclass can leave the base class's type parameters open, as in the following example:

```
class Stack<T>           {...}
class SpecialStack<T> : Stack<T> {...}
```

Or the subclass can close the generic type parameters with a concrete type:

```
class IntStack : Stack<int> {...}
```

A subtype can also introduce fresh type arguments:

```
class List<T>           {...}
class KeyedList<T, TKey> : List<T> {...}
```

## Self-Referencing Generic Declarations

A type can name *itself* as the concrete type when closing a type argument:

```
public interface IEquatable<T> { bool Equals (T obj); }

public class Balloon : IEquatable<Balloon>
{
    public bool Equals (Balloon b) { ... }
}
```

The following are also legal:

```
class Foo<T> where T : IComparable<T> { ... }
class Bar<T> where T : Bar<T> { ... }
```

## Static Data

Static data is unique for each closed type:

```
class Bob<T> { public static int Count; }
...
Console.WriteLine (++Bob<int>.Count); // 1
Console.WriteLine (++Bob<int>.Count); // 2
Console.WriteLine (++Bob<string>.Count); // 1
Console.WriteLine (++Bob<object>.Count); // 1
```

## Covariance (C# 4.0)

---

### NOTE

Covariance and contravariance are advanced concepts. The motivation behind their introduction into C# 4.0 was to allow generic interfaces and generics (in particular, those defined in the Framework, such as `IEnumerable<T>`) to work *more as you'd expect*. You can benefit from this without understanding the details behind covariance and contravariance.

---

Assuming `S` subclasses `B`, type `X` is *covariant* for its type parameter if `X<S>` allows a conversion to `X<B>`. In other words, type `IFoo<T>` is covariant for `T` if the following is legal:

```
IFoo<string> s = ...;
IFoo<object> b = s;
```

As of C# 4.0, generic interfaces permit covariance for type parameters marked with the `out` modifier (as do generic delegates). To illustrate, suppose that the `Stack<T>` class that we wrote at the start of this section implements the following interface:

```
public interface IPoppable<out T> { T Pop(); }
```

The `out` modifier on `T` indicates that `T` is used only in *output positions* (e.g., return types for methods). The `out` modifier flags the interface as *covariant* and allows us to do this:

```
// Assuming that Bear subclasses Animal:
var bears = new Stack<Bear>();
bears.Push (new Bear());

// Because bears implements IPoppable<Bear>,
// we can convert it to IPoppable<Animal>:
IPoppable<Animal> animals = bears; // Legal
Animal a = animals.Pop();
```

The cast from `bears` to `animals` is permitted by the compiler—by virtue of the interface being covariant.



---

**NOTE**

The `IEnumerator<T>` and `IEnumerable<T>` interfaces (see “Enumeration and Iterators” on page 125) are marked as covariants from Framework 4.0. This allows you to cast `IEnumerable<string>` to `IEnumerable<object>`, for instance.

---

The compiler will generate an error if you use a covariant type parameter in an *input* position (e.g., a parameter to a method or a writable property). The purpose of this limitation is to guarantee compile-time type safety. For instance, it prevents us from adding a `Push(T)` method to that interface which consumers could abuse with the seemingly benign operation of pushing a camel onto an `IPoppable<Animal>` (remember that the underlying type in our example is a stack of bears). In order to define a `Push(T)` method, `T` must in fact be *contravariant*.

---

**NOTE**

C# supports covariance (and contravariance) only for elements with *reference conversions*—not *boxing conversions*. So, if you wrote a method that accepted a parameter of type `IPoppable<object>`, you could call it with `IPoppable<string>`, but not `IPoppable<int>`.

---

## Contravariance (C# 4.0)

We just saw that a type `X` is covariant for its type parameter if `X<S>` allows a conversion to `X<B>` where `S` subclasses `B`. A type is *contravariant* when you can convert in the reverse direction—from `X<B>` to `X<S>`. This is supported on interfaces and delegates when the type parameter only appears in *input* positions, designated with the `in` modifier. Extending our previous example, if the `Stack<T>` class implements the following interface:

```
public interface IPushable<in T> { void Push (T obj); }
```

we can legally do this:

```
IPushable<Animal> animals = new Stack<Animal>();
IPushable<Bear> bears = animals; // Legal
bears.Push (new Bear());
```

Mirroring covariance, the compiler will report an error if you try to use a contravariant type parameter in an output position (e.g., as a return value, or in a readable property).

## Delegates

A delegate dynamically wires up a method caller to its target method. There are two aspects to a delegate: *type* and *instance*. A *delegate type* defines a *protocol* to which the caller and target will conform, comprising a list of parameter types and a return type. A *delegate instance* is an object that refers to one or more target methods conforming to that protocol.

A delegate instance literally acts as a delegate for the caller: the caller invokes the delegate, and then the delegate calls the target method. This indirection decouples the caller from the target method.

A delegate type declaration is preceded by the keyword `delegate`, but otherwise it resembles an (abstract) method declaration. For example:

```
delegate int Transformer (int x);
```

To create a delegate instance, you can assign a method to a delegate variable:

```
class Test
{
    static void Main()
    {
        Transformer t = Square; // Create delegate instance
        int result = t(3); // Invoke delegate
        Console.Write (result); // 9
    }
    static int Square (int x) { return x * x; }
}
```

Invoking a delegate is just like invoking a method (since the delegate's purpose is merely to provide a level of indirection):

```
t(3);
```

The statement `Transformer t = Square` is shorthand for:

```
Transformer t = new Transformer (Square);
```

And `t(3)` is shorthand for:

```
t.Invoke (3);
```

A delegate is similar to a *callback*, a general term that captures constructs such as C function pointers.

## Writing Plug-in Methods with Delegates

A delegate variable is assigned a method *dynamically*. This is useful for writing plug-in methods. In this example, we have a utility method named `Transform` that applies a transform to each element in an integer array. The `Transform` method has a delegate parameter, for specifying a plug-in transform.

```
public delegate int Transformer (int x);

class Util
{
    public static void Transform (int[] values,
                                  Transformer t)
    {
        for (int i = 0; i < values.Length; i++)
            values[i] = t (values[i]);
    }
}

class Test
{
    static void Main()
    {
        int[] values = { 1, 2, 3 };
        Util.Transform (values, Square);
        foreach (int i in values)
            Console.Write (i + " ");    // 1 4 9
    }
}
```

```
static int Square (int x) { return x * x; }
}
```

## Multicast Delegates

All delegate instances have *multicast* capability. This means that a delegate instance can reference not just a single target method, but also a list of target methods. The `+` and `+=` operators combine delegate instances. For example:

```
SomeDelegate d = SomeMethod1;
d += SomeMethod2;
```

The last line is functionally the same as:

```
d = d + SomeMethod2;
```

Invoking `d` will now call both `SomeMethod1` and `SomeMethod2`. Delegates are invoked in the order they are added.

The `-` and `-=` operators remove the right delegate operand from the left delegate operand. For example:

```
d -= SomeMethod1;
```

Invoking `d` will now cause only `SomeMethod2` to be invoked.

Calling `+` or `+=` on a delegate variable with a `null` value is legal, as is calling `-=` on a delegate variable with a single target (which will result in the delegate instance being `null`).

---

### NOTE

Delegates are *immutable*, so when you call `+=` or `-=`, you're in fact creating a *new* delegate instance and assigning it to the existing variable.

---

If a multicast delegate has a nonvoid return type, the caller receives the return value from the last method to be invoked. The preceding methods are still called, but their return values are discarded. In most scenarios in which multicast delegates are used, they have `void` return types, so this subtlety does not arise.

All delegate types implicitly derive from `System.MulticastDelegate`, which inherits from `System.Delegate`. C# compiles `+`, `-`, `+=`, and `-=` operations made on a delegate to the static `Combine` and `Remove` methods of the `System.Delegate` class.

## Instance Versus Static Method Targets

When a delegate object is assigned to an *instance* method, the delegate object must maintain a reference not only to the method, but also to the *instance* to which the method belongs. The `System.Delegate` class's `Target` property represents this instance (and will be null for a delegate referencing a static method).

## Generic Delegate Types

A delegate type may contain generic type parameters. For example:

```
public delegate T Transformer<T> (T arg);
```

Here's how we could use this delegate type:

```
static double Square (double x) { return x * x; }

static void Main()
{
    Transformer<double> s = Square;
    Console.WriteLine (s (3.3));           // 10.89
}
```

## The Func and Action Delegates

With generic delegates, it becomes possible to write a small set of delegate types that are so general they can work for methods of any return type and any (reasonable) number of arguments. These delegates are the `Func` and `Action` delegates, defined in the `System` namespace (the `in` and `out` annotations indicate *variance*, which we will cover shortly):

```
delegate TResult Func <out TResult> ();
delegate TResult Func <in T, out TResult> (T arg);
```

```

delegate TResult Func <in T1, in T2, out TResult>
    (T1 arg1, T2 arg2);
... and so on, up to T16

delegate void Action ();
delegate void Action <in T> (T arg);
delegate void Action <in T1, in T2> (T1 arg1, T2 arg2);
... and so on, up to T16

```

These delegates are extremely general. The `Transformer` delegate in our previous example can be replaced with a `Func` delegate that takes a single argument of type `T` and returns a same-typed value:

```

public static void Transform<T> (
    T[] values, Func<T,T> transformer)
{
    for (int i = 0; i < values.Length; i++)
        values[i] = transformer (values[i]);
}

```

The only practical scenarios not covered by these delegates are `ref/out` and pointer parameters.

## Delegate Compatibility

Delegate types are all incompatible with each other, even if their signatures are the same:

```

delegate void D1(); delegate void D2();
...
D1 d1 = Method1;
D2 d2 = d1;           // Compile-time error

```

The following, however, is permitted:

```

D2 d2 = new D2 (d1);

```

Delegate instances are considered equal if they have the same type and method target(s). For multicast delegates, the order of the method targets is significant.

Download from Library of Wow! eBook  
<[www.wowebook.com](http://www.wowebook.com)>

## Return type variance

When you call a method, you may get back a type that is more specific than what you asked for. This is ordinary polymorphic behavior. In keeping with this, a delegate target method may return a more specific type than described by the delegate. This is *covariance*, and has been supported since C# 2.0:

```
delegate object ObjectRetriever();
...
static void Main()
{
    ObjectRetriever o = new ObjectRetriever (GetString);
    object result = o();
    Console.WriteLine (result);    // hello
}
static string GetString() { return "hello"; }
```

The `ObjectRetriever` expects to get back an `object`, but an `object` subclass will also do because delegate return types are *covariant*.

## Parameter variance

When you call a method, you can supply arguments that have more specific types than the parameters of that method. This is ordinary polymorphic behavior. In keeping with this, a delegate target method may have *less* specific parameter types than described by the delegate. This is called *contravariance*:

```
delegate void StringAction (string s);
...
static void Main()
{
    StringAction sa = new StringAction (ActOnObject);
    sa ("hello");
}
static void ActOnObject (object o)
{
    Console.WriteLine (o);    // hello
}
```

---

**NOTE**

The standard event pattern is designed to help you leverage delegate parameter contravariance through its use of the common `EventArgs` base class. For example, you can have a single method invoked by two different delegates, one passing a `MouseEventArgs` and the other passing a `KeyEventArgs`.

---

## Type parameter variance for generic delegates (C# 4.0)

In “Generics” on page 92, we saw how type parameters can be covariant and contravariant for generic interfaces. The same capability also exists for generic delegates in C# 4.0. If you’re defining a generic delegate type, it’s good practice to:

- Mark a type parameter used only on the return value as covariant (`out`).
- Mark any type parameters used only on parameters as contravariant (`in`).

Doing so allows conversions to work naturally by respecting inheritance relationships between types. The following delegate (defined in the `System` namespace) is covariant for `TResult`:

```
delegate TResult Func<out TResult>();
```

allowing:

```
Func<string> x = ...;  
Func<object> y = x;
```

The following delegate (defined in the `System` namespace) is contravariant for `T`:

```
delegate void Action<in T> (T arg);
```

allowing:

```
Action<object> x = ...;  
Action<string> y = x;
```



## Events

When using delegates, two emergent roles commonly appear: *broadcaster* and *subscriber*. The *broadcaster* is a type that contains a delegate field. The broadcaster decides when to broadcast, by invoking the delegate. The *subscribers* are the method target recipients. A subscriber decides when to start and stop listening, by calling `+=` and `-=` on the broadcaster's delegate. A subscriber does not know about, or interfere with, other subscribers.

Events are a language feature that formalizes this pattern. An **event** is a construct that exposes just the subset of delegate features required for the broadcaster/subscriber model. The main purpose of events is to *prevent subscribers from interfering with each other*.

The easiest way to declare an event is to put the **event** keyword in front of a delegate member:

```
public class Broadcaster
{
    public event ProgressReporter Progress;
}
```

Code within the **Broadcaster** type has full access to **Progress** and can treat it as a delegate. Code outside of **Broadcaster** can only perform `+=` and `-=` operations on the **Progress** event.

In the following example, the **Stock** class fires its **Price Changed** event every time the **Price** of the **Stock** changes:

```
public delegate void PriceChangedHandler
(decimal oldPrice, decimal newPrice);
public class Stock
{
    string symbol; decimal price;

    public Stock (string symbol) { this.symbol = symbol; }

    public event PriceChangedHandler PriceChanged;
```

```

public decimal Price
{
    get { return price; }
    set
    {
        if (price == value) return;
        // Fire event if invocation list isn't empty:
        if (PriceChanged != null)
            PriceChanged (price, value);
        price = value;
    }
}
}

```

If we remove the `event` keyword from our example so that `PriceChanged` becomes an ordinary delegate field, our example would give the same results. However, `Stock` would be less robust, in that subscribers could do the following things to interfere with each other:

- Replace other subscribers by reassigning `PriceChanged` (instead of using the `+=` operator).
- Clear all subscribers (by setting `PriceChanged` to `null`).
- Broadcast to other subscribers by invoking the delegate.

Events can be virtual, overridden, abstract, or sealed. They can also be static.

## Standard Event Pattern

The .NET Framework defines a standard pattern for writing events. Its purpose is to provide consistency across both Framework and user code. Here is the preceding example refactored with this pattern:

```

public class PriceChangedEventArgs : EventArgs
{
    public readonly decimal LastPrice, NewPrice;

    public PriceChangedEventArgs (decimal lastPrice,
                                  decimal newPrice)
    {
        LastPrice = lastPrice; NewPrice = newPrice;
    }
}

```

```

    }
}

public class Stock
{
    string symbol; decimal price;

    public Stock (string symbol) { this.symbol = symbol; }

    public event EventHandler<PriceChangedEventArgs>
        PriceChanged;

    protected virtual void OnPriceChanged
        (PriceChangedEventArgs e)
    {
        if (PriceChanged != null) PriceChanged (this, e);
    }

    public decimal Price
    {
        get { return price; }
        set
        {
            if (price == value) return;
            OnPriceChanged (new PriceChangedEventArgs (price,
                value));
            price = value;
        }
    }
}

```

At the core of the standard event pattern is `System.EventArgs`: a predefined Framework class with no members (other than the static `Empty` property). `EventArgs` is a base class for conveying information for an event. In this example, we subclass `EventArgs` to convey the old and new prices when a `Price Changed` event is fired.

The generic `System.EventHandler` delegate is also part of the .NET Framework and is defined as follows:

```

public delegate void EventHandler<TEventArgs>
    (object source, TEventArgs e)
    where TEventArgs : EventArgs;

```

---

### NOTE

Before C# 2.0 (when generics were added to the language), the solution was to instead write a custom event-handling delegate for each EventArgs type, as follows:

```
delegate void PriceChangedHandler
(object sender,
 PriceChangedEventArgs e);
```

For historical reasons, most events within the Framework use delegates defined in this way.

---

A protected virtual method, named `On-event-name`, centralizes firing of the event. This allows subclasses to fire the event (which is usually desirable) and also allows subclasses to insert code before and after the event is fired.

Here's how we could use our `Stock` class:

```
static void Main()
{
    Stock stock = new Stock ("THPW");
    stock.Price = 27.10M;

    stock.PriceChanged += stock_PriceChanged;
    stock.Price = 31.59M;
}

static void stock_PriceChanged
(object sender, PriceChangedEventArgs e)
{
    if ((e.NewPrice - e.LastPrice) / e.LastPrice > 0.1M)
        Console.WriteLine ("Alert, 10% price increase!");
}
```

For events that don't carry additional information, the Framework also provides a nongeneric `EventHandler` delegate. We can demonstrate this by rewriting our `Stock` class such that the `PriceChanged` event fires *after* the price changes. This means that no additional information need be transmitted with the event:

```
public class Stock
{
```

```

string symbol; decimal price;

public Stock (string symbol) {this.symbol = symbol;}

public event EventHandler PriceChanged;

protected virtual void OnPriceChanged (EventArgs e)
{
    if (PriceChanged != null) PriceChanged (this, e);
}

public decimal Price
{
    get { return price; }
    set
    {
        if (price == value) return;
        price = value;
        OnPriceChanged (EventArgs.Empty);
    }
}
}

```

Note that we also used the `EventArgs.Empty` property—this saves instantiating an instance of `EventArgs`.

## Event Accessors

An event's *accessors* are the implementations of its `+=` and `-=` functions. By default, accessors are implemented implicitly by the compiler. Consider this event declaration:

```
public event EventHandler PriceChanged;
```

The compiler converts this to the following:

- A private delegate field.
- A public pair of event accessor functions, whose implementations forward the `+=` and `-=` operations to the private delegate field.

You can take over this process by defining *explicit* event accessors. Here's a manual implementation of the `PriceChanged` event from our previous example:

```

EventHandler _priceChanged; // Private delegate

public event EventHandler PriceChanged
{
    add { _priceChanged += value; }
    remove { _priceChanged -= value; }
}

```

This example is functionally identical to C#'s default accessor implementation (except that C# also ensures thread safety around updating the delegate). By defining event accessors ourselves, we instruct C# not to generate default field and accessor logic.

With explicit event accessors, you can apply more complex strategies to the storage and access of the underlying delegate. This is useful when the event accessors are merely relays for another class that is broadcasting the event, or when explicitly implementing an interface that declares an event:

```

public interface IFoo { event EventHandler Ev; }
class Foo : IFoo
{
    EventHandler ev;
    event EventHandler IFoo.Ev
    {
        add { ev += value; } remove { ev -= value; }
    }
}

```

## Lambda Expressions

A lambda expression is an unnamed method written in place of a delegate instance. The compiler immediately converts the lambda expression to either:

- A delegate instance.
- An *expression tree*, of type `Expression<TDelegate>`, representing the code inside the lambda expression in a traversable object model. This allows the lambda expression to be interpreted later at runtime; we describe the process in Chapter 8 of *C# 4.0 in a Nutshell* (O'Reilly).

Given the following delegate type:

```
delegate int Transformer (int i);
```

we could assign and invoke the lambda expression `x => x * x` as follows:

```
Transformer sqr = x => x * x;
Console.WriteLine (sqr(3));    // 9
```

---

### NOTE

Internally, the compiler resolves lambda expressions of this type by writing a private method, and moving the expression's code into that method.

---

A lambda expression has the following form:

```
(parameters) => expression-or-statement-block
```

For convenience, you can omit the parentheses if and only if there is exactly one parameter of an inferable type.

In our example, there is a single parameter, `x`, and the expression is `x * x`:

```
x => x * x;
```

Each parameter of the lambda expression corresponds to a delegate parameter, and the type of the expression (which may be `void`) corresponds to the return type of the delegate.

In our example, `x` corresponds to parameter `i`, and the expression `x * x` corresponds to the return type `int`, therefore being compatible with the `Transformer` delegate.

A lambda expression's code can be a *statement block* instead of an expression. We can rewrite our example as follows:

```
x => { return x * x; };
```

Lambda expressions are used most commonly with the `Func` and `Action` delegates, so you will most often see our earlier expression written as follows:

```
Func<int,int> sqr = x => x * x;
```

The compiler can usually *infer* the type of lambda parameters contextually. When this is not the case, you can specify parameter types explicitly:

```
Func<int,int> sqr = (int x) => x * x;
```

Here's an example of an expression that accepts two parameters:

```
Func<string,string,int> totalLength =
    (s1, s2) => s1.Length + s2.Length;

int total = totalLength ("hello", "world"); // total=10;
```

Assuming `Clicked` is an event of type `EventHandler`, the following attaches an event handler via a lambda expression:

```
obj.Clicked += (sender,args) => Console.Write ("Click");
```

## Capturing Outer Variables

A lambda expression can reference the local variables and parameters of the method in which it's defined (*outer variables*). For example:

```
static void Main()
{
    int factor = 2;
    Func<int, int> multiplier = n => n * factor;
    Console.WriteLine (multiplier (3));           // 6
}
```

Outer variables referenced by a lambda expression are called *captured variables*. A lambda expression that captures variables is called a *closure*. Captured variables are evaluated when the delegate is actually *invoked*, not when the variables were *captured*:

```
int factor = 2;
Func<int, int> multiplier = n => n * factor;
factor = 10;
Console.WriteLine (multiplier (3));           // 30
```

Lambda expressions can themselves update captured variables:



```

int seed = 0;
Func<int> natural = () => seed++;
Console.WriteLine (natural());           // 0
Console.WriteLine (natural());           // 1
Console.WriteLine (seed);                 // 2

```

Captured variables have their lifetimes extended to that of the delegate. In the following example, the local variable `seed` would ordinarily disappear from scope when `Natural` finished executing. But because `seed` has been *captured*, its lifetime is extended to that of the capturing delegate, `natural`:

```

static Func<int> Natural()
{
    int seed = 0;
    return () => seed++;    // Returns a closure
}
static void Main()
{
    Func<int> natural = Natural();
    Console.WriteLine (natural());         // 0
    Console.WriteLine (natural());         // 1
}

```

## Capturing iteration variables

When you capture iteration variables in `for` and `foreach` statements, C# treats those iteration variables as though they were declared *outside* the loop. This means that the *same* variable is captured in each iteration. The following program writes 333 instead of writing 012:

```

Action[] actions = new Action[3];

for (int i = 0; i < 3; i++)
    actions [i] = () => Console.Write (i);

foreach (Action a in actions) a();    // 333

```

Each closure (shown in boldface) captures the same variable, `i`. When the delegates are later invoked, each delegate sees `i`'s value at the time of *invocation*—which is 3. The solution, if we want to write 012, is to assign the iteration variable to a local variable that's scoped *inside* the loop:

```

Action[] actions = new Action[3];
for (int i = 0; i < 3; i++)
{
    int loopScopedI = i;
    actions [i] = () => Console.Write (loopScopedI);
}
foreach (Action a in actions) a();    // 012

```

This then causes the closure to capture a *different* variable on each iteration.

## Anonymous Methods

Anonymous methods are a C# 2.0 feature that has been largely subsumed by lambda expressions. An anonymous method is like a lambda expression, except that it lacks implicitly typed parameters, expression syntax (an anonymous method must always be a statement block), and the ability to compile to an expression tree.

To write an anonymous method, you include the `delegate` keyword followed (optionally) by a parameter declaration and then a method body. For example, given this delegate:

```
delegate int Transformer (int i);
```

we could write and call an anonymous method as follows:

```
Transformer sqr = delegate (int x) {return x * x;};
Console.WriteLine (sqr(3));    // 9

```

The first line is semantically equivalent to the following lambda expression:

```
Transformer sqr = (int x) => {return x * x;};
```

Or simply:

```
Transformer sqr = x => x * x;
```

A unique feature of anonymous methods is that you can omit the parameter declaration entirely—even if the delegate expects them. This can be useful in declaring events with a default empty handler:

```
public event EventHandler Clicked = delegate { };
```

This avoids the need for a null check before firing the event. The following is also legal (notice the lack of parameters):

```
Clicked += delegate { Console.Write ("clicked"); };
```

Anonymous methods capture outer variables in the same way lambda expressions do.

## try Statements and Exceptions

A `try` statement specifies a code block subject to error-handling or cleanup code. The `try block` must be followed by a `catch block`, a `finally block`, or both. The `catch block` executes when an error occurs in the `try block`. The `finally block` executes after execution leaves the `try block` (or if present, the `catch block`), to perform cleanup code, whether or not an error occurred.

A `catch block` has access to an `Exception` object that contains information about the error. You use a `catch block` to either compensate for the error or *rethrow* the exception. You rethrow an exception if you merely want to log the problem, or if you want to rethrow a new, higher-level exception type.

A `finally block` adds determinism to your program, by always executing no matter what. It's useful for cleanup tasks such as closing network connections.

A `try` statement looks like this:

```
try
{
    ... // exception may get thrown within execution of
        // this block
}
catch (ExceptionA ex)
{
    ... // handle exception of type ExceptionA
}
catch (ExceptionB ex)
{
    ... // handle exception of type ExceptionB
}
```

```

finally
{
    ... // clean-up code
}

```

Consider the following code:

```

int x = 3, y = 0;
Console.WriteLine (x / y);

```

Because *y* is zero, the runtime throws a `DivideByZeroException`, and our program terminates. We can prevent this by catching the exception as follows:

```

try
{
    int x = 3, y = 0;
    Console.WriteLine (x / y);
}
catch (DivideByZeroException ex)
{
    Console.Write ("y cannot be zero. ");
}
// Execution resumes here after exception...

```

---

#### NOTE

This is a simple example to illustrate exception handling. We could deal with this particular scenario better in practice by checking explicitly for the divisor being zero before calling `Calc`.

Exceptions are relatively expensive to handle, taking hundreds of clock cycles.

---

When an exception is thrown, the CLR performs a test:

*Is execution currently within a try statement that can catch the exception?*

- If so, execution is passed to the compatible `catch` block. If the `catch` block successfully finishes executing, execution moves to the next statement after the `try` statement (if present, executing the `finally` block first).

- If not, execution jumps back to the caller of the function, and the test is repeated (after executing any `finally` blocks that wrap the statement).

If no function in the call stack takes responsibility for the exception, an error dialog is displayed to the user, and the program terminates.

## The catch Clause

A `catch` clause specifies what type of exception to catch. This must either be `System.Exception` or a subclass of `System.Exception`. Catching `System.Exception` catches all possible errors. This is useful when:

- Your program can potentially recover, regardless of the specific exception type.
- You plan to rethrow the exception (perhaps after logging it).
- Your error handler is the last resort, prior to termination of the program.

More typically, though, you catch *specific exception types*, in order to avoid having to deal with circumstances for which your handler wasn't designed (e.g., an `OutOfMemoryException`).

You can handle multiple exception types with multiple `catch` clauses:

```
try
{
    DoSomething();
}
catch (IndexOutOfRangeException ex) { ... }
catch (FormatException ex)         { ... }
catch (OverflowException ex)       { ... }
```

Only one `catch` clause executes for a given exception. If you want to include a safety net to catch more general exceptions (such as `System.Exception`) you must put the more specific handlers *first*.

An exception can be caught without specifying a variable, if you don't need to access its properties:

```
catch (StackOverflowException) // no variable
{ ... }
```

Furthermore, you can omit both the variable and the type (meaning that all exceptions will be caught):

```
catch { ... }
```

---

### NOTE

In languages other than C#, it is possible (though not recommended) to throw an object that does not derive from `Exception`. The CLR automatically wraps that object in a `RuntimeWrappedException` class (which does derive from `Exception`).

---

## The finally Block

A `finally` block always executes—whether or not an exception is thrown and whether or not the `try` block runs to completion. `finally` blocks are typically used for cleanup code.

A `finally` block executes either:

- After a `catch` block finishes.
- After control leaves the `try` block because of a `jump` statement (e.g., `return` or `goto`).
- After the `try` block ends.

A `finally` block helps add determinism to a program. In the following example, the file that we open *always* gets closed, regardless of whether:

- The `try` block finishes normally.
- Execution returns early because the file is empty (`EndOfStream`).
- An `IOException` is thrown while reading the file.

For example:

```
static void ReadFile()
{
    StreamReader reader = null; // In System.IO namespace
    try
    {
        reader = File.OpenText ("file.txt");
        if (reader.EndOfStream) return;
        Console.WriteLine (reader.ReadToEnd());
    }
    finally
    {
        if (reader != null) reader.Dispose();
    }
}
```

In this example, we closed the file by calling `Dispose` on the `StreamReader`. Calling `Dispose` on an object, within a `finally` block, is a standard convention throughout the .NET Framework and is supported explicitly in C# through the `using` statement.

## The using statement

Many classes encapsulate unmanaged resources, such as file handles, graphics handles, or database connections. These classes implement `System.IDisposable`, which defines a single parameterless method named `Dispose` to clean up these resources. The `using` statement provides an elegant syntax for calling `Dispose` on an `IDisposable` object within a `finally` block.

The following:

```
using (StreamReader reader = File.OpenText ("file.txt"))
{
    ...
}
```

is precisely equivalent to:

```
StreamReader reader = File.OpenText ("file.txt");
try
{
    ...
}
```

```

}
finally
{
    if (reader != null) ((IDisposable)reader).Dispose();
}

```

## Throwing Exceptions

Exceptions can be thrown either by the runtime or in user code. In this example, `Display` throws a `System.ArgumentNullException`:

```

static void Display (string name)
{
    if (name == null)
        throw new ArgumentNullException ("name");

    Console.WriteLine (name);
}

```

## Rethrowing an exception

You can capture and rethrow an exception as follows:

```

try { ... }
catch (Exception ex)
{
    // Log error
    ...
    throw;           // Rethrow same exception
}

```

Rethrowing in this manner lets you log an error without *swallowing* it. It also lets you back out of handling an exception should circumstances turn out to be outside what you expected.

---

### NOTE

If we replaced `throw` with `throw ex`, the example would still work, but the `StackTrace` property of the exception would no longer reflect the original error.

---



The other common scenario is to rethrow a more specific or meaningful exception type:

```
try
{
    ... // parse a date of birth from XML element data
}
catch (FormatException ex)
{
    throw new XmlException ("Invalid date of birth", ex);
}
```

When rethrowing a different exception, you can populate the `InnerException` property with the original exception to aid debugging. Nearly all types of exceptions provide a constructor for this purpose (such as in our example).

## Key Properties of System.Exception

The most important properties of `System.Exception` are the following:

### StackTrace

A string representing all the methods that are called from the origin of the exception to the catch block.

### Message

A string with a description of the error.

### InnerException

The inner exception (if any) that caused the outer exception. This, itself, may have another `InnerException`.

## Common Exception Types

The following exception types are used widely throughout the CLR and .NET Framework. You can throw these yourself or use them as base classes for deriving custom exception types.

### System.ArgumentException

Thrown when a function is called with a bogus argument. This generally indicates a program bug.

**System.ArgumentNullException**

Subclass of `ArgumentException` that's thrown when a function argument is (unexpectedly) `null`.

**System.ArgumentOutOfRangeException**

Subclass of `ArgumentException` that's thrown when a (usually numeric) argument is too big or too small. For example, this is thrown when passing a negative number into a function that accepts only positive values.

**System.InvalidOperationException**

Thrown when the state of an object is unsuitable for a method to successfully execute, regardless of any particular argument values. Examples include reading an unopened file or getting the next element from an enumerator where the underlying list has been modified partway through the iteration.

**System.NotSupportedException**

Thrown to indicate that a particular functionality is not supported. A good example is calling the `Add` method on a collection for which `IsReadOnly` returns `true`.

**System.NotImplementedException**

Thrown to indicate that a function has not yet been implemented.

**System.ObjectDisposedException**

Thrown when the object upon which the function is called has been disposed.

---

**NOTE**

In Framework 4.0, *Code contracts* eliminate the need for `ArgumentException` (and its subclasses). Code contracts are covered in Chapter 13 of *C# 4.0 in a Nutshell* (O'Reilly).

---

# Enumeration and Iterators

## Enumeration

An *enumerator* is a read-only, forward-only cursor over a *sequence of values*. An enumerator is an object that implements `System.Collections.IEnumerator` or `System.Collections.Generic.IEnumerator<T>`.

The `foreach` statement iterates over an *enumerable* object. An enumerable object is the logical representation of a sequence. It is not itself a cursor, but an object that produces cursors over itself. An enumerable either implements `IEnumerable/IEnumerable<T>` or has a method named `GetEnumerator` that returns an *enumerator*.

The enumeration pattern is as follows:

```
class Enumerator // Typically implements IEnumerator<T>
{
    public IteratorVariableType Current { get {...} }
    public bool MoveNext() {...}
}
class Enumerable // Typically implements IEnumerable<T>
{
    public Enumerator GetEnumerator() {...}
}
```

Here is the high-level way of iterating through the characters in the word *beer* using a `foreach` statement:

```
foreach (char c in "beer") Console.WriteLine (c);
```

Here is the low-level way of iterating through the characters in *beer* without using a `foreach` statement:

```
using (var enumerator = "beer".GetEnumerator())
while (enumerator.MoveNext())
{
    var element = enumerator.Current;
    Console.WriteLine (element);
}
```

If the enumerator implements `IDisposable`, the `foreach` statement also acts as a `using` statement, implicitly disposing the enumerator object as in the earlier example.

## Collection Initializers

You can instantiate and populate an enumerable object in a single step. For example:

```
using System.Collections.Generic;
...

List<int> list = new List<int> {1, 2, 3};
```

The compiler translates the last line into the following:

```
List<int> list = new List<int>();
list.Add (1); list.Add (2); list.Add (3);
```

This requires that the enumerable object implements the `System.Collections.IEnumerable` interface, and that it has an `Add` method that has the appropriate number of parameters for the call.

## Iterators

Whereas a `foreach` statement is a *consumer* of an enumerator, an iterator is a *producer* of an enumerator. In this example, we use an iterator to return a sequence of Fibonacci numbers (where each number is the sum of the previous two):

```
using System;
using System.Collections.Generic;

class Test
{
    static void Main()
    {
        foreach (int fib in Fibs(6))
            Console.Write (fib + " ");
    }

    static IEnumerable<int> Fibs(int fibCount)
    {
```

```

    for (int i = 0, prevFib = 1, curFib = 1;
        i < fibCount;
        i++)
    {
        yield return prevFib;
        int newFib = prevFib+curFib;
        prevFib = curFib;
        curFib = newFib;
    }
}

```

*OUTPUT: 1 1 2 3 5 8*

Whereas a `return` statement expresses “Here’s the value you asked me to return from this method,” a `yield return` statement expresses “Here’s the next element you asked me to yield from this enumerator.” On each `yield` statement, control is returned to the caller, but the callee’s state is maintained so that the method can continue executing as soon as the caller enumerates the next element. The lifetime of this state is bound to the enumerator, such that the state can be released when the caller has finished enumerating.

---

#### NOTE

The compiler converts iterator methods into private classes that implement `IEnumerable<T>` and/or `IEnumerator<T>`. The logic within the iterator block is “inverted” and spliced into the `MoveNext` method and `Current` property on the compiler-written enumerator class. This means that when you call an iterator method, all you’re doing is instantiating the compiler-written class; none of your code actually runs! Your code runs only when you start enumerating over the resultant sequence, typically with a `foreach` statement.

---

## Iterator Semantics

An iterator is a method, property, or indexer that contains one or more `yield` statements. An iterator must return one of the

following four interfaces (otherwise, the compiler will generate an error):

```
System.Collections.IEnumerable
System.Collections.IEnumerator
System.Collections.Generic.IEnumerable<T>
System.Collections.Generic.IEnumerator<T>
```

Iterators that return an *enumerator* interface tend to be used less often. They're useful when writing a custom collection class: typically, you name the iterator `GetEnumerator` and have your class implement `IEnumerable<T>`.

Iterators that return an *enumerable* interface are more common—and simpler to use because you don't have to write a collection class. The compiler, behind the scenes, writes a private class implementing `IEnumerable<T>` (as well as `IEnumerator<T>`).

## Multiple yield statements

An iterator can include multiple `yield` statements:

```
static void Main()
{
    foreach (string s in Foo())
        Console.Write (s + " ");    // One Two Three
}

static IEnumerable<string> Foo()
{
    yield return "One";
    yield return "Two";
    yield return "Three";
}
```

## yield break

The `yield break` statement indicates that the iterator block should exit early, without returning more elements. We can modify `Foo` as follows to demonstrate:

```
static IEnumerable<string> Foo (bool breakEarly)
{
    yield return "One";
    yield return "Two";
    if (breakEarly) yield break;
    yield return "Three";
}
```

---

### WARNING

A return statement is illegal in an iterator block—you must use `yield break` instead.

---

## Composing Sequences

Iterators are highly composable. We can extend our Fibonacci example by adding the following method to the class:

```
static IEnumerable<int> EvenNumbersOnly (
    IEnumerable<int> sequence)
{
    foreach (int x in sequence)
        if ((x % 2) == 0)
            yield return x;
}
```

We can then output even Fibonacci numbers as follows:

```
foreach (int fib in EvenNumbersOnly (Fibs (6)))
    Console.Write (fib + " "); // 2 8
```

Each element is not calculated until the last moment—when requested by a `MoveNext()` operation. [Figure 5](#) shows the data requests and data output over time.

The composability of the iterator pattern is essential in building LINQ queries.

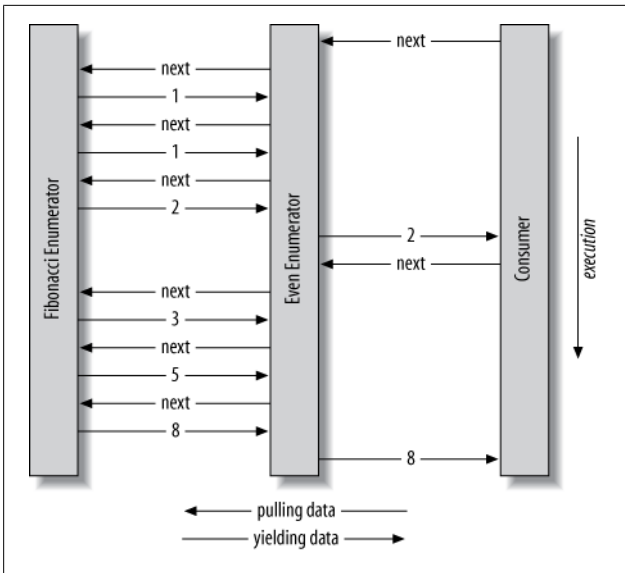

Figure 5. Composing sequences

## Nullable Types

Reference types can represent a nonexistent value with a null reference. Value types, however, cannot ordinarily represent null values. For example:

```
string s = null;    // OK - reference type.
int i = null;      // Compile error - int cannot be null.
```

To represent null in a value type, you must use a special construct called a *nullable type*. A nullable type is denoted with a value type followed by the ? symbol:

```
int? i = null;    // OK - Nullable Type
Console.WriteLine (i == null); // True
```



## Nullable Basics

### Nullable<T> struct

T? translates into `System.Nullable<T>`. `Nullable<T>` is a lightweight immutable structure, having only two fields, to represent `Value` and `HasValue`. The essence of `System.Nullable<T>` is very simple:

```
public struct Nullable<T> where T : struct
{
    public T Value {get;}
    public bool HasValue {get;}
    public T GetValueOrDefault();
    public T GetValueOrDefault (T defaultValue);
    ...
}
```

This code:

```
int? i = null;
Console.WriteLine (i == null);           // True
```

translates to:

```
Nullable<int> i = new Nullable<int>();
Console.WriteLine (! i.HasValue);       // True
```

Attempting to retrieve `Value` when `HasValue` is false throws an `InvalidOperationException`. `GetValueOrDefault()` returns `Value` if `HasValue` is true; otherwise, it returns `new T()` or a specified custom default value.

The default value of T? is null.

### Implicit and explicit nullable conversions

The conversion from T to T? is implicit, and from T? to T is explicit. For example:

```
int? x = 5;           // implicit
int y = (int)x;      // explicit
```

The explicit cast is directly equivalent to calling the nullable object's `Value` property. Hence, an `InvalidOperationException` is thrown if `HasValue` is false.

## Boxing and unboxing nullable values

When `T?` is boxed, the boxed value on the heap contains `T`, not `T?`. This optimization is possible because a boxed value is a reference type that can already express `null`.

`C#` also permits the unboxing of nullable types with the `as` operator. The result will be `null` if the cast fails:

```
object o = "string";
int? x = o as int?;
Console.WriteLine (x.HasValue);    // False
```

## Operator Lifting

The `Nullable<T>` struct does not define operators such as `<`, `>`, or even `==`. Despite this, the following code compiles and executes correctly:

```
int? x = 5;
int? y = 10;
bool b = x < y;    // true
```

This works because the compiler steals or “lifts” the less-than operator from the underlying value type. Semantically, it translates the preceding comparison expression into this:

```
bool b = (x.HasValue && y.HasValue)
        ? (x.Value < y.Value)
        : false;
```

In other words, if both `x` and `y` have values, it compares via `int`’s less-than operator; otherwise, it returns `false`.

Operator lifting means you can implicitly use `T`’s operators on `T?`. You can define operators for `T?` in order to provide special-purpose null behavior, but in the vast majority of cases, it’s best to rely on the compiler automatically applying systematic nullable logic for you.

The compiler performs null logic differently depending on the category of operator.

## Equality operators (== and !=)

Lifted equality operators handle nulls just like reference types do. This means two null values are equal:

```
Console.WriteLine (    null ==    null); // True
Console.WriteLine ((bool?)null == (bool?)null); // True
```

Further:

- If exactly one operand is null, the operands are unequal.
- If both operands are non-null, their Values are compared.

## Relational operators (<, <=, >=, >)

The relational operators work on the principle that it is meaningless to compare null operands. This means comparing a null value to either a null or a non-null value returns **false**.

```
bool b = x < y;    // Translation:
bool b = (x == null || y == null)
? false
: (x.Value < y.Value);

// b is false (assuming x is 5 and y is null)
```

## All other operators (+, -, \*, /, %, &, |, ^, <<, >>, ++, --, !, ~)

These operators return null when any of the operands are null. This pattern should be familiar to SQL users:

```
int? c = x + y;    // Translation:

int? c = (x == null || y == null)
? null
: (int?) (x.Value + y.Value);

// c is null (assuming x is 5 and y is null)
```

An exception is when the & and | operators are applied to bool?, which we will discuss shortly.

Download from Library of Wow! eBook  
<[www.wowebook.com](http://www.wowebook.com)>

## Mixing nullable and nonnullable operators

You can mix and match nullable and nonnullable types (this works because there is an implicit conversion from T to T?):

```
int? a = null;
int b = 2;
int? c = a + b; // c is null - equivalent to a + (int?)b
```

## bool? with & and | Operators

When supplied operands of type `bool?`, the `&` and `|` operators treat `null` as an *unknown value*. So, `null | true` is true, because:

- If the unknown value is false, the result would be true.
- If the unknown value is true, the result would be true.

Similarly, `null & false` is false. This behavior would be familiar to SQL users. The following example enumerates other combinations:

```
bool? n = null, f = false, t = true;
Console.WriteLine (n | n); // (null)
Console.WriteLine (n | f); // (null)
Console.WriteLine (n | t); // True
Console.WriteLine (n & n); // (null)
Console.WriteLine (n & f); // False
Console.WriteLine (n & t); // (null)
```

## Null Coalescing Operator

The `??` operator is the null coalescing operator, and it can be used with both nullable types and reference types. It says “If the operand is nonnull, give it to me; otherwise, give me a default value.” For example:

```
int? x = null;
int y = x ?? 5; // y is 5

int? a = null, b = 1, c = 2;
Console.Write (a ?? b ?? c); // 1 (first nonnull value)
```

The ?? operator is equivalent to calling `GetValueOrDefault` with an explicit default value, except that the expression passed to `GetValueOrDefault` is never evaluated if the variable is not null.

## Operator Overloading

Operators can be overloaded to provide more natural syntax for custom types. Operator overloading is most appropriately used for implementing custom structs that represent fairly primitive data types. For example, a custom numeric type is an excellent candidate for operator overloading.

The following symbolic operators can be overloaded:

```
+ - * / ++ -- ! ~ % & | ^
== != < << >> >
```

Implicit and explicit conversions can also be overridden (with the `implicit` and `explicit` keywords), as can the literals `true` and `false`, and the unary `+` and `-` operators.

The compound assignment operators (e.g., `+=`, `/=`) are automatically overridden when you override the noncompound operators (e.g., `+`, `/`).

## Operator Functions

An operator is overloaded by declaring an *operator function*. An operator function must be static, and at least one of the operands must be the type in which the operator function is declared.

In the following example, we define a struct called `Note`, representing a musical note, and then overload the `+` operator:

```
public struct Note
{
    int value;

    public Note (int semitonesFromA)
    { value = semitonesFromA; }
```

```

public static Note operator + (Note x, int semitones)
{
    return new Note (x.value + semitones);
}
}

```

This overload allows us to add an `int` to a `Note`:

```

Note B = new Note (2);
Note CSharp = B + 2;

```

Since we overrode `+`, we can use `+=` too:

```

CSharp += 2;

```

## Overloading Equality and Comparison Operators

Equality and comparison operators are often overridden when writing structs, and in rare cases with classes. Special rules and obligations come with overloading these operators:

### *Pairing*

The C# compiler enforces that operators that are logical pairs are both defined. These operators are (`==` `!=`), (`<` `>`), and (`<=` `>=`).

### *Equals and GetHashCode*

If you overload `==` and `!=`, you will usually need to override `object`'s `Equals` and `GetHashCode` methods, so that collections and hashtables will work reliably with the type.

### *IComparable and IComparable<T>*

If you overload `<` and `>`, you would also typically implement `IComparable` and `IComparable<T>`.

Extending the previous example, here's how we could overload `Note`'s equality operators:

```

public static bool operator == (Note n1, Note n2)
{
    return n1.value == n2.value;
}
public static bool operator != (Note n1, Note n2)
{
    return !(n1.value == n2.value);
}

```

```

public override bool Equals (object otherNote)
{
    if (!(otherNote is Note)) return false;
    return this == (Note)otherNote;
}
public override int GetHashCode()
{
    return value.GetHashCode();    // Use value's hashcode
}

```

## Custom Implicit and Explicit Conversions

Implicit and explicit conversions are overloadable operators. These conversions are typically overloaded to make converting between strongly related types (such as numeric types) concise and natural.

As explained in the discussion on types, the rationale behind implicit conversions is that they should always succeed and not lose information during conversion. Otherwise, explicit conversions should be defined.

In the following example, we define conversions between our musical `Note` type and a `double` (which represents the frequency in hertz of that note):

```

...
// Convert to hertz
public static implicit operator double (Note x)
{
    return 440 * Math.Pow (2,(double) x.value / 12 );
}

// Convert from hertz (accurate to nearest semitone)
public static explicit operator Note (double x)
{
    return new Note ((int) (0.5 + 12 * (Math.Log(x/440)
        / Math.Log(2)) ));
}
...

Note n =(Note)554.37; // explicit conversion
double x = n;        // implicit conversion

```

---

**NOTE**

This example is somewhat contrived: in real life, these conversions might be better implemented with a `ToFrequency` method and a (static) `FromFrequency` method.

---

Custom conversions are ignored by the `as` and `is` operators.

## Extension Methods

*Extension methods* allow an existing type to be extended with new methods, without altering the definition of the original type. An extension method is a static method of a static class, where the `this` modifier is applied to the first parameter. The type of the first parameter will be the type that is extended. For example:

```
public static class StringHelper
{
    public static bool IsCapitalized (this string s)
    {
        if (string.IsNullOrEmpty (s)) return false;
        return char.IsUpper (s[0]);
    }
}
```

The `IsCapitalized` extension method can be called as though it were an instance method on a string, as follows:

```
Console.Write ("Perth".IsCapitalized());
```

An extension method call, when compiled, is translated back into an ordinary static method call:

```
Console.Write (StringHelper.IsCapitalized ("Perth"));
```

Interfaces can be extended, too:

```
public static T First<T> (this IEnumerable<T> sequence)
{
    foreach (T element in sequence)
        return element;
    throw new InvalidOperationException ("No elements!");
}
```



```
...
Console.WriteLine ("Seattle".First()); // S
```

## Extension Method Chaining

Extension methods, like instance methods, provide a tidy way to chain functions. Consider the following two functions:

```
public static class StringHelper
{
    public static string Pluralize (this string s) {...}
    public static string Capitalize (this string s) {...}
}
```

`x` and `y` are equivalent and both evaluate to "Sausages", but `x` uses extension methods, whereas `y` uses static methods:

```
string x = "sausage".Pluralize().Capitalize();

string y = StringHelper.Capitalize
           (StringHelper.Pluralize ("sausage"));
```

## Ambiguity and Resolution

### Namespaces

An extension method cannot be accessed unless the namespace is in scope (typically imported with a `using` statement).

### Extension methods versus instance methods

Any compatible instance method will always take precedence over an extension method—even when the extension method's parameters are more specifically type-matched.

### Extension methods versus extension methods

If two extension methods have the same signature, the extension method must be called as an ordinary static method to disambiguate the method to call. If one extension method has more specific arguments, however, the more specific method takes precedence.

## Anonymous Types

An anonymous type is a simple class created on the fly to store a set of values. To create an anonymous type, you use the `new` keyword followed by an object initializer, specifying the properties and values the type will contain. For example:

```
var dude = new { Name = "Bob", Age = 1 };
```

The compiler resolves this by writing a private nested type with read-only properties for `Name` (type `string`) and `Age` (type `int`). You must use the `var` keyword to reference an anonymous type, because the type's name is compiler-generated.

The property name of an anonymous type can be inferred from an expression that is itself an identifier. For example:

```
int Age = 1;
var dude = new { Name = "Bob", Age };
```

is equivalent to:

```
var dude = new { Name = "Bob", Age = Age };
```

You can create arrays of anonymous types as follows:

```
var dudes = new[]
{
    new { Name = "Bob", Age = 30 },
    new { Name = "Mary", Age = 40 }
};
```

Anonymous types are used primarily when writing LINQ queries.

## LINQ

LINQ, or Language Integrated Query, allows you to write structured type-safe queries over local object collections and remote data sources.

LINQ lets you query any collection implementing `IEnumerable<T>`, whether an array, list, XML DOM, or remote data source (such as a table in SQL Server). LINQ offers the benefits

of both compile-time type checking and dynamic query composition.

---

#### NOTE

A good way to experiment with LINQ is to download [LINQPad](#). LINQPad lets you interactively query local collections and SQL databases in LINQ without any setup and is preloaded with numerous examples.

---

## LINQ Fundamentals

The basic units of data in LINQ are *sequences* and *elements*. A sequence is any object that implements the generic `IEnumerable` interface, and an element is each item in the sequence. In the following example, `names` is a sequence, and `Tom`, `Dick`, and `Harry` are elements:

```
string[] names = { "Tom", "Dick", "Harry" };
```

A sequence such as this we call a *local sequence* because it represents a local collection of objects in memory.

A *query operator* is a method that transforms a sequence. A typical query operator accepts an *input sequence* and emits a transformed *output sequence*. In the `Enumerable` class in `System.Linq`, there are around 40 query operators; all implemented as static extension methods. These are called *standard query operators*.

---

#### NOTE

LINQ also supports sequences that can be dynamically fed from a remote data source such as SQL Server. These sequences additionally implement the `IQueryable<>` interface and are supported through a matching set of standard query operators in the `Queryable` class.

---

## A simple query

A query is an expression that transforms sequences with one or more query operators. The simplest query comprises one input sequence and one operator. For instance, we can apply the `Where` operator on a simple array to extract those whose length is at least four characters, as follows:

```
string[] names = { "Tom", "Dick", "Harry" };

IEnumerable<string> filteredNames =
    System.Linq.Enumerable.Where (
        names, n => n.Length >= 4);

foreach (string n in filteredNames)
    Console.Write (n + "|");           // Dick|Harry|
```

Because the standard query operators are implemented as extension methods, we can call `Where` directly on `names`—as though it were an instance method:

```
IEnumerable<string> filteredNames =
    names.Where (n => n.Length >= 4);
```

(For this to compile, you must import the `System.Linq` namespace with a `using` directive.) The `Where` method in `System.Linq.Enumerable` has the following signature:

```
static IEnumerable<TSource> Where<TSource> (
    this IEnumerable<TSource> source,
    Func<TSource,bool> predicate)
```

`source` is the *input sequence*; `predicate` is a delegate that is invoked on each input *element*. `Where` method includes all elements in the *output sequence*, for which the delegate returns true. Internally, it's implemented with an iterator—here's its source code:

```
foreach (TSource element in source)
    if (predicate (element))
        yield return element;
```

## Projecting

Another fundamental query operator is the `Select` method. This transforms (*projects*) each element in the input sequence with a given lambda expression:

```
string[] names = { "Tom", "Dick", "Harry" };

IEnumerable<string> upperNames =
    names.Select (n => n.ToUpper());

foreach (string n in upperNames)
    Console.Write (n + "|");    // TOM|DICK|HARRY|
```

A query can project into an anonymous type:

```
var query = names.Select (n => new {
    Name = n,
    Length = n.Length
});

foreach (var row in query)
    Console.WriteLine (row);
```

Here's the result:

```
{ Name = Tom, Length = 3 }
{ Name = Dick, Length = 4 }
{ Name = Harry, Length = 5 }
```

## Take and Skip

The original ordering of elements within an input sequence is significant in LINQ. Some query operators rely on this behavior, such as `Take`, `Skip`, and `Reverse`. The `Take` operator outputs the first *x* elements, discarding the rest:

```
int[] numbers = { 10, 9, 8, 7, 6 };
IEnumerable<int> firstThree = numbers.Take (3);
// firstThree is { 10, 9, 8 }
```

The `Skip` operator ignores the first *x* elements, and outputs the rest:

```
IEnumerable<int> lastTwo = numbers.Skip (3);
```

## Element operators

Not all query operators return a sequence. The *element* operators extract one element from the input sequence; examples are `First`, `Last`, `Single`, and `ElementAt`:

```
int[] numbers = { 10, 9, 8, 7, 6 };
int firstNumber = numbers.First();           // 10
int lastNumber = numbers.Last();            // 6
int secondNumber = numbers.ElementAt (2);    // 8
int firstOddNum = numbers.First (n => n%2 == 1); // 9
```

All of these operators throw an exception if no elements are present. To get a null/empty return value instead of an exception, use `FirstOrDefault`, `LastOrDefault`, `SingleOrDefault` or `ElementAtOrDefault`.

The `Single` and `SingleOrDefault` methods are equivalent to `First` and `FirstOrDefault` except that they throw an exception if there's more than one match. This behavior is useful when querying a database table for a row by primary key.

## Aggregation operators

The *aggregation* operators return a scalar value; usually of numeric type. The most commonly used aggregation operators are `Count`, `Min`, `Max` and `Average`:

```
int[] numbers = { 10, 9, 8, 7, 6 };
int count = numbers.Count();           // 5
int min = numbers.Min();               // 6
int max = numbers.Max();               // 10
double avg = numbers.Average();       // 8
```

`Count` accepts an optional predicate, which indicates whether to include a given element. The following counts all even numbers:

```
int evenNums = numbers.Count (n => n % 2 == 0); // 3
```

The `Min`, `Max` and `Average` operators accept an optional argument that transforms each element prior to it being aggregated:

```
int maxRemainderAfterDivBy5 = numbers.Max
    (n => n % 5);           // 4
```

The following calculates the root-mean-square of numbers:

```
double rms = Math.Sqrt (numbers.Average (n => n * n));
```

## Quantifiers

The *quantifiers* return a `bool` value. The quantifiers are `Contains`, `Any`, `All`, and `SequenceEquals` (which compares two sequences):

```
int[] numbers = { 10, 9, 8, 7, 6 };

bool hasTheNumberNine = numbers.Contains (9); // true
bool hasMoreThanZeroElements = numbers.Any(); // true
bool hasOddNum = numbers.Any (n => n % 2 == 1); // true
bool allOddNums = numbers.All (n => n % 2 == 1); // false
```

## Set operators

The *set* operators accept two same-typed input sequences. `Concat` appends one sequence to another; `Union` does the same but with duplicates removed:

```
int[] seq1 = { 1, 2, 3 }, seq2 = { 3, 4, 5 };

IEnumerable<int>
    concat = seq1.Concat (seq2), // { 1, 2, 3, 3, 4, 5 }
    union = seq1.Union (seq2), // { 1, 2, 3, 4, 5 }
```

The other two operators in this category are `Intersect` and `Except`:

```
IEnumerable<int>
    commonality = seq1.Intersect (seq2), // { 3 }
    difference1 = seq1.Except (seq2), // { 1, 2 }
    difference2 = seq2.Except (seq1); // { 4, 5 }
```

## Deferred Execution

An important feature of many query operators is that they execute not when constructed, but when *enumerated* (in other words, when `MoveNext` is called on its enumerator). Consider the following query:

```
var numbers = new List<int> { 1 };
numbers.Add (1);
```

```

IEnumerable<int> query = numbers.Select (n => n * 10);
numbers.Add (2);    // Sneak in an extra element

foreach (int n in query)
    Console.Write (n + "|");           // 10|20|

```

The extra number that we sneaked into the list *after* constructing the query is included in the result, because it's not until the `foreach` statement runs that any filtering or sorting takes place. This is called *deferred* or *lazy* evaluation. Deferred execution decouples query *construction* from query *execution*, allowing you to construct a query in several steps, as well as making it possible to query a database without retrieving all the rows to the client. All standard query operators provide deferred execution, with the following exceptions:

- Operators that return a single element or scalar value (the *element operators*, *aggregation operators* and *quantifiers*)
- The following *conversion* operators:

`ToArray`, `ToList`, `ToDictionary`, `ToLookup`

The conversion operators are useful, in part, because they defeat lazy evaluation. This can be useful when:

- You want to “freeze” or cache the results at a certain point in time.
- You want to avoid re-executing a computationally intensive query, or a query with a remote data source such as a LINQ to SQL table. (A side effect of lazy evaluation is that the query gets re-evaluated should you later re-enumerate it).

The following example illustrates the `ToList` operator:

```

var numbers = new List<int>() { 1, 2 };

List<int> timesTen = numbers
    .Select (n => n * 10)
    .ToList();    // Executes immediately into a List<int>

numbers.Clear();
Console.WriteLine (timesTen.Count);    // Still 2

```



---

### WARNING

Subqueries provide another level of indirection. Everything in a subquery is subject to deferred execution—including aggregation and conversion methods, because the subquery is itself executed only lazily upon demand. Assuming `names` is a string array, a subquery looks like this:

```
names.Where (
    n => n.Length ==
        names.Min (n2 => n2.Length)
)
```

---

## Standard Query Operators

The standard query operators (as implemented in the `System.Linq.Enumerable` class) can be divided into 12 categories, summarized in [Table 1](#).

*Table 1. Query operator categories*

Category	Description	Deferred execution?
Filtering	Returns a subset of elements that satisfy a given condition	Yes
Projecting	Transforms each element with a lambda function, optionally expanding subsequences	Yes
Joining	Meshes elements of one collection with another, using a time-efficient lookup strategy	Yes
Ordering	Returns a reordering of a sequence	Yes
Grouping	Groups a sequence into subsequences.	Yes
Set	Accepts two same-typed sequences, and returns their commonality, sum, or difference	Yes
Element	Picks a single element from a sequence	No
Aggregation	Performs a computation over a sequence, returning a scalar value (typically a number)	No

Category	Description	Deferred execution?
Quantifiers	Performs a computation over a sequence, returning true or false	No
Conversion: Import	Converts a nongeneric sequence to a (queryable) generic sequence	Yes
Conversion: Export	Converts a sequence to an array, list, dictionary, or lookup, forcing immediate evaluation	No
Generation	Manufactures a simple sequence	Yes

Tables 2 through 13 summarize each of the query operators. The operators shown in bold have special support in C# (see “Query Expressions” on page 152).

Table 2. Filtering operators

Method	Description
<b>Where</b>	Returns a subset of elements that satisfy a given condition
Take	Returns the first x elements, and discards the rest
Skip	Ignores the first x elements, and returns the rest
TakeWhile	Emits elements from the input sequence until the given predicate is true
SkipWhile	Ignores elements from the input sequence until the given predicate is true, and then emits the rest
Distinct	Returns a collection that excludes duplicates

Table 3. Projection operators

Method	Description
<b>Select</b>	Transforms each input element with a given lambda expression
<b>SelectMany</b>	Transforms each input element, then flattens and concatenates the resultant subsequences

Table 4. Joining operators

Method	Description
<b>Join</b>	Applies a lookup strategy to match elements from two collections, emitting a flat result set
<b>GroupJoin</b>	As above, but emits a <i>hierarchical</i> result set

Table 5. Ordering operators

Method	Description
<b>OrderBy, ThenBy</b>	Returns the elements sorted in ascending order
<b>OrderByDescending, ThenByDescending</b>	Returns the elements sorted in descending order
<b>Reverse</b>	Returns the elements in reverse order

Table 6. Grouping operators

Method	Description
<b>GroupBy</b>	Groups a sequence into subsequences

Table 7. Set operators

Method	Description
<b>Concat</b>	Concatenates two sequences
<b>Union</b>	Concatenates two sequences, removing duplicates
<b>Intersect</b>	Returns elements present in both sequences
<b>Except</b>	Returns elements present in the first, but not the second sequence

Table 8. Element operators

Method	Description
<b>First, FirstOrDefault</b>	Returns the first element in the sequence, or the first element satisfying a given predicate
<b>Last, LastOrDefault</b>	Returns the last element in the sequence, or the last element satisfying a given predicate

Method	Description
Single, SingleOrDefault	Equivalent to First/FirstOrDefault, but throws an exception if there is more than one match
ElementAt, ElementAtOrDefault	Returns the element at the specified position
DefaultIfEmpty	Returns null or default(TSource) if the sequence has no elements

Table 9. Aggregation operators

Method	Description
Count, LongCount	Returns the total number of elements in the input sequence, or the number of elements satisfying a given predicate
Min, Max	Returns the smallest or largest element in the sequence
Sum, Average	Calculates a numeric sum or average over elements in the sequence
Aggregate	Performs a custom aggregation

Table 10. Qualifiers

Method	Description
Contains	Returns true if the input sequence contains the given element
Any	Returns true if any elements satisfy the given predicate
All	Returns true if all elements satisfy the given predicate
SequenceEqual	Returns true if the second sequence has identical elements to the input sequence

Table 11. Conversion operators (import)

Method	Description
OfType	Converts IEnumerable to IEnumerable<T>, discarding wrongly typed elements
Cast	Converts IEnumerable to IEnumerable<T>, throwing an exception if there are any wrongly typed elements

Table 12. Table conversion operators (export)

Method	Description
ToArray	Converts IEnumerable<T> to T[]
ToList	Converts IEnumerable<T> to List<T>
ToDictionary	Converts IEnumerable<T> to Dictionary<TKey, TValue>
ToLookup	Converts IEnumerable<T> to ILookup<TKey, TElement>
AsEnumerable	Downcasts to IEnumerable<T>
AsQueryable	Casts or converts to IQueryable<T>

Table 13. Generation operators

Method	Description
Empty	Creates an empty sequence
Repeat	Creates a sequence of repeating elements
Range	Creates a sequence of integers

In addition to these, Framework 4.0 provides a new Zip operator, which enumerates two sequences in step (like a zipper), returning a sequence based on applying a function over each element pair.

## Chaining Query Operators

To build more complex queries, you chain query operators together. For example, the following query extracts all strings containing the letter “a,” sorts them by length, and then converts the results to uppercase:

```
string[] names = { "Tom", "Dick", "Harry", "Mary", "Jay" };

IEnumerable<string> query = names
    .Where (n => n.Contains ("a"))
    .OrderBy (n => n.Length)
    .Select (n => n.ToUpper());
```

```
foreach (string name in query)
    Console.WriteLine (name + "|");

// RESULT: JAY|MARY|HARRY|
```

Where, `OrderBy`, and `Select` are all standard query operators that resolve to extension methods in the `Enumerable` class. The `Where` operator emits a filtered version of the input sequence; `OrderBy` emits a sorted version of its input sequence; `Select` emits a sequence where each input element is transformed or *projected* with a given lambda expression (`n.ToUpper()`, in this case). Data flows from left to right through the chain of operators, so the data is first filtered, then sorted, then projected. The end result resembles a production line of conveyor belts, as illustrated in [Figure 6](#).

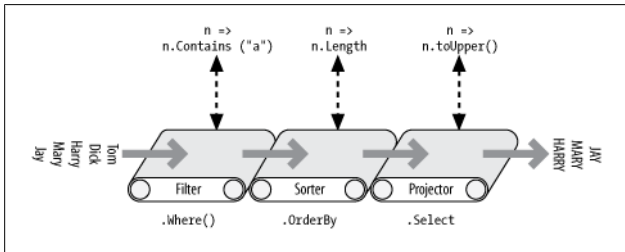

Figure 6. Chaining query operators

Deferred execution is honored throughout with operators, so no filtering, sorting, or projecting takes place until the query is actually enumerated.

## Query Expressions

So far, we've written queries by calling extension methods in the `Enumerable` class. In this book, we describe this as *fluent syntax*. `C#` also provides special language support for writing queries, called *query expressions*. Here's the preceding query expressed as a query expression:

```
using System.Linq;
...
```

```
string[] names = { "Tom", "Dick", "Harry", "Mary", "Jay" };

IEnumerable<string> query =
    from n in names
    where n.Contains ("a")
    orderby n.Length
    select n.ToUpper();
```

A query expression always starts with a **from** clause, and ends with either a **select** or **group** clause. The **from** clause declares a *range variable* (in this case, *n*) which you can think of as traversing the input collection—rather like `foreach`. [Figure 7](#) illustrates the complete syntax.

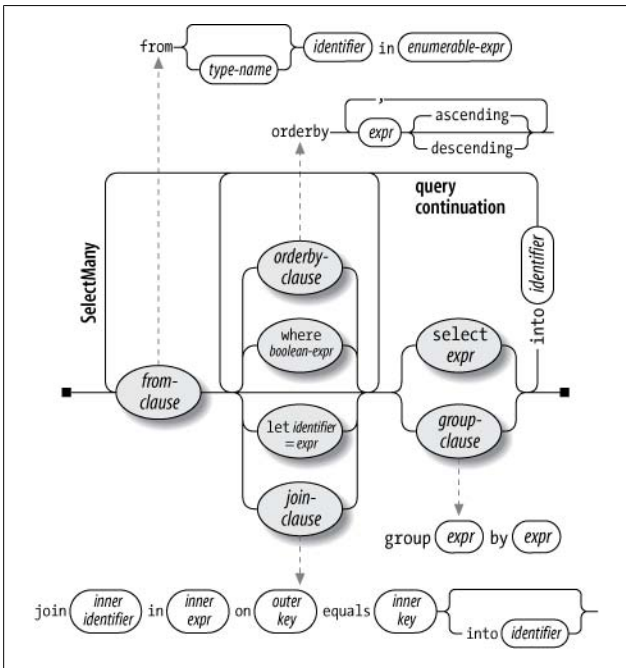

Figure 7. Query expression syntax

---

**NOTE**

If you're familiar with SQL, LINQ's query expression syntax—with the `from` clause first and the `select` clause last—might look bizarre. Query expression syntax is actually more logical because the clauses appear *in the order they're executed*. This allows Visual Studio to prompt you with IntelliSense as you type, as well as simplifying the scoping rules for subqueries.

---

The compiler processes query expressions by translating them to fluent syntax. It does this in a fairly mechanical fashion—much like it translates `foreach` statements into calls to `GetEnumerator` and `MoveNext`:

```
IEnumerable<string> query = names
    .Where (n => n.Contains ("a"))
    .OrderBy (n => n.Length)
    .Select (n => n.ToUpper());
```

The `Where`, `OrderBy`, and `Select` operators then resolve, using the same rules that would apply if the query were written in fluent syntax. In this case, they bind to extension methods in the `Enumerable` class (assuming you've imported the `System.Linq` namespace) because `names` implements `IEnumerable<string>`. The compiler doesn't specifically favor the `Enumerable` class, however, when translating query syntax. You can think of the compiler as mechanically injecting the words "Where," "OrderBy," and "Select" into the statement, and then compiling it as though you'd typed the method names yourself. This offers flexibility in how they resolve—the operators in LINQ to SQL and Entity Framework queries, for instance, bind instead to the extension methods in the `Queryable` class.

## Query expressions versus fluent queries

Query expressions and fluent queries each have advantages.

Query expressions support only a small subset of query operators, namely:



Where, Select, SelectMany  
 OrderBy, ThenBy, OrderByDescending, ThenByDescending  
 GroupBy, Join, GroupJoin

For queries that use other operators, you must either write entirely in fluent syntax or construct mixed-syntax queries, for instance:

```
string[] names = { "Tom", "Dick", "Harry", "Mary", "Jay" };

IEnumerable<string> query =
    from n in names
    where n.Length == names.Min (n2 => n2.Length)
    select n;
```

This query returns names whose length matches that of the shortest (“Tom” and “Jay”). The subquery (in bold) calculates the minimum length of each name, and evaluates to 3. We have to use fluent syntax for the subquery, because the `Min` operator has no support in query expression syntax. We can, however, still use query syntax for the outer query.

The main advantage of query syntax is that it can radically simplify queries that involve the following:

- A `let` clause for introducing a new variable alongside the range variable
- Multiple generators (`SelectMany`) followed by an outer range variable reference
- A `Join` or `GroupJoin` equivalent, followed by an outer range variable reference

## The `let` Keyword

The `let` keyword introduces a new variable alongside the range variable. For instance, suppose we want to list all names, whose length without vowels, is greater than two characters:

```
string[] names = { "Tom", "Dick", "Harry", "Mary", "Jay" };

IEnumerable<string> query =
    from n in names
    let vowelless = Regex.Replace (n, "[aeiou]", "")
    where vowelless.Length > 2
```

```

orderby vowelless
select n + " - " + vowelless;

```

The output from enumerating this query is:

```

Dick - Dck
Harry - Hrry
Mary - Mry

```

The `let` clause performs a calculation on each element, without losing the original element. In our query, the subsequent clauses (`where`, `orderby`, and `select`) have access to both `n` and `vowelless`. A query can include any multiple `let` clauses, and they can be interspersed with additional `where` and `join` clauses.

The compiler translates the `let` keyword by projecting into temporary anonymous type that contains both the original and transformed elements:

```

IEnumerable<string> query = names
    .Select (n => new
        {
            n = n,
            vowelless = Regex.Replace (n, "[aeiou]", "")
        }
    )
    .Where (temp0 => (temp0.vowelless.Length > 2))
    .OrderBy (temp0 => temp0.vowelless)
    .Select (temp0 => ((temp0.n + " - ") + temp0.vowelless))

```

## Query Continuations

If you want to add clauses *after* a `select` or `group` clause, you must use the `into` keyword to “continue” the query. For instance:

```

from c in "The quick brown tiger".Split()
select c.ToUpper() into upper
where upper.StartsWith ("T")
select upper

// RESULT: "THE", "TIGER"

```

Following an `into` clause, the previous range variable is out of scope.

The compiler translates queries with an `into` keyword simply into a longer chain of operators:

```
"The quick brown tiger".Split()
    .Select (c => c.ToUpper())
    .Where (upper => upper.StartsWith ("T"))
```

(It omits the final `Select(upper=>upper)` because it's redundant.)

## Multiple Generators

A query can include multiple generators (`from` clauses). For example:

```
int[] numbers = { 1, 2, 3 };
string[] letters = { "a", "b" };

IEnumerable<string> query = from n in numbers
                          from l in letters
                          select n.ToString() + l;
```

The result is a cross product, rather like you'd get with nested `foreach` loops:

```
"1a", "1b", "2a", "2b", "3a", "3b"
```

When there's more than one `from` clause in a query, the compiler emits a call to `SelectMany`:

```
IEnumerable<string> query = numbers.SelectMany (
    n => letters,
    (n, l) => (n.ToString() + l));
```

`SelectMany` performs nested looping. It enumerates every element in the source collection (`numbers`), transforming each element with the first lambda expression (`letters`). This generates a sequence of *subsequences*, which it then enumerates. The final output elements are determined by the second lambda expression (`n.ToString()+l`).

If you subsequently apply a `where` clause, you can filter the cross product and project a result akin to a *join*:

```
string[] players = { "Tom", "Jay", "Mary" };
```

```

IEnumerable<string> query =
    from name1 in players
    from name2 in players
    where name1.CompareTo (name2) < 0
    orderby name1, name2
    select name1 + " vs " + name2;

```

```
RESULT: { "Jay vs Mary", "Jay vs Tom", "Mary vs Tom" }
```

The translation of this query into fluent syntax is more complex, requiring a temporary anonymous projection. The ability to perform this translation automatically is one of the key benefits of query expressions.

The expression in the second generator is allowed to use first range variable:

```
string[] fullNames =
    { "Anne Williams", "John Fred Smith", "Sue Green" };
```

```

IEnumerable<string> query =
    from fullName in fullNames
    from name in fullName.Split()
    select name + " came from " + fullName;

```

```

Anne came from Anne Williams
Williams came from Anne Williams
John came from John Fred Smith

```

This works because the expression `fullName.Split` emits a *sequence* (an array of strings).

Multiple generators are used extensively in database queries, to flatten parent-child relationships and to perform manual joins.

## Joining

LINQ provides *joining* operators for performing keyed lookup-based joins. The joining operators support only a subset of the functionality you get with multiple generators/`SelectMany`, but are more performant with local queries because they use a hashtable-based lookup strategy rather than performing nested

loops. (With LINQ to SQL and Entity Framework queries, the joining operators have no advantage over multiple generators).

The joining operators support *equi-joins* only (i.e., the joining condition must use the equality operator). There are two methods: `Join` and `GroupJoin`. `Join` emits a flat result set whereas `GroupJoin` emits a hierarchical result set.

The syntax for a flat join is:

```
from outer-var in outer-sequence
join inner-var in inner-sequence
    on outer-key-expr equals inner-key-expr
```

For example, given the following collections:

```
var customers = new[]
{
    new { ID = 1, Name = "Tom" },
    new { ID = 2, Name = "Dick" },
    new { ID = 3, Name = "Harry" }
};
var purchases = new[]
{
    new { CustomerID = 1, Product = "House" },
    new { CustomerID = 2, Product = "Boat" },
    new { CustomerID = 2, Product = "Car" },
    new { CustomerID = 3, Product = "Holiday" }
};
```

we could perform a join as follows:

```
IEnumerable<string> query =
    from c in customers
    join p in purchases on c.ID equals p.CustomerID
    select c.Name + " bought a " + p.Product;
```

The compiler translates this to:

```
customers.Join (
    purchases, // outer collection
    c => c.ID, // inner collection
    p => p.CustomerID, // outer key selector
    (c, p) => // inner key selector
        c.Name + " bought a " + p.Product // result selector
);
```

Here's the result:

```
Tom bought a House
Dick bought a Boat
Dick bought a Car
Harry bought a Holiday
```

With local sequences, the join operators are more efficient at processing large collections than `SelectMany` because they first preload the inner sequence into a keyed hashtable-based lookup. With a database query, however, you could achieve the same result equally efficiently, as follows:

```
from c in customers
from p in purchases
where c.ID == p.CustomerID
select c.Name + " bought a " + p.Product;
```

## GroupJoin

`GroupJoin` does the same work as `Join`, but instead of yielding a flat result, it yields a hierarchical result, grouped by each outer element.

The query expression syntax for `GroupJoin` is the same as for `Join`, but is followed by the `into` keyword. Here's a basic example, using the `customers` and `purchases` collections we set up in the previous section:

```
IEnumerable<IEnumerable<Purchase>> query =
    from c in customers
    join p in purchases on c.ID equals p.CustomerID
    into custPurchases
    select custPurchases; // custPurchases is a sequence
```

---

### NOTE

An `into` clause translates to `GroupJoin` only when it appears directly after a `join` clause. After a `select` or `group` clause it means *query continuation*. The two uses of the `into` keyword are quite different, although they have one feature in common: they both introduce a new query variable.

---

The result is a sequence of sequences, which we could enumerate as follows:

```
foreach (IEnumerable<Purchase> purchaseSequence in query)
    foreach (Purchase p in purchaseSequence)
        Console.WriteLine (p.Description);
```

This isn't very useful, however, because `outerSeq` has no reference to the outer customer. More commonly, you'd reference the outer range variable in the projection:

```
from c in customers
join p in purchases on c.ID equals p.CustomerID
into custPurchases
select new { CustName = c.Name, custPurchases };
```

We could obtain the same result (but less efficiently, for local queries) by projecting into an anonymous type which included a subquery:

```
from c in customers
select new
{
    CustName = c.Name,
    custPurchases =
        purchases.Where (p => c.ID == p.CustomerID)
}
```

## Ordering

The `orderby` keyword sorts a sequence. You can specify any number of expressions upon which to sort:

```
string[] names = { "Tom", "Dick", "Harry", "Mary", "Jay" };

IEnumerable<string> query = from n in names
                           orderby n.Length, n
                           select n;
```

This sorts first by length, then name, so the result is:

```
Jay, Tom, Dick, Mary, Harry
```

The compiler translates the first `orderby` expression to a call to `OrderBy`, and subsequent expressions to a call to `ThenBy`:

```

IEnumerable<string> query = names
    .OrderBy (n => n.Length)
    .ThenBy (n => n)

```

The `ThenBy` operator *refines* (not *replaces*) the previous sorting.

You can include the `descending` keyword after any of the `orderby` expressions:

```
orderby n.Length descending, n
```

This translates to:

```
.OrderByDescending (n => n.Length).ThenBy (n => n)
```

---

### NOTE

The ordering operators return an extended type of `IEnumerable<T>` called `IOrderedEnumerable<T>`. This interface defines the extra functionality required by the `ThenBy` operators.

---

## Grouping

`GroupBy` organizes a flat input sequence into sequences of *groups*. For example, the following groups a sequence of names by their length:

```

string[] names = { "Tom", "Dick", "Harry", "Mary", "Jay" };

var query = from name in names
            group name by name.Length;

```

The compiler translates this query into this:

```

IEnumerable<IGrouping<int,string>> query =
    names.GroupBy (name => name.Length);

```

Here's how to enumerate the result:

```

foreach (IGrouping<int,string> grouping in query)
{
    Console.WriteLine ("\r\n Length=" + grouping.Key + ":");
    foreach (string name in grouping)
        Console.WriteLine (" " + name);
}

```



```

Length=3: Tom Jay
Length=4: Dick Mary
Length=5: Harry

```

`Enumerable.GroupBy` works by reading the input elements into a temporary dictionary of lists so that all elements with the same key end up in the same sublist. It then emits a sequence of *groupings*. A grouping is a sequence with a `Key` property:

```

public interface IGrouping <TKey,TElement>
    : IEnumerable<TElement>, IEnumerable
{
    // Key applies to the subsequence as a whole
    TKey Key { get; }
}

```

By default, the elements in each grouping are untransformed input elements, unless you specify an `elementSelector` argument. The following projects each input element to uppercase:

```

from name in names
group name.ToUpper() by name.Length

```

which translates to this:

```

names.GroupBy (
    name => name.Length,
    name => name.ToUpper() )

```

The subcollections are not emitted in order of key. `GroupBy` does no *sorting* (in fact, it preserves the original ordering.) To sort, you must add an `OrderBy` operator (which means first adding an `into` clause, because `group...by` ordinarily ends a query):

```

from name in names
group name.ToUpper() by name.Length into grouping
orderby grouping.Key
select grouping

```

Query continuations are often used in a `group...by` query. The next query filters out groups that have exactly two matches in them:

Download from Library of Wow! eBook  
<www.wowebook.com>

```

from name in names
group name.ToUpper() by name.Length into grouping
where grouping.Count() == 2
select grouping

```

---

### NOTE

A `where` after a `group...by` is equivalent to `HAVING` in SQL. It applies to each subsequence or grouping as a whole, rather than the individual elements.

---

## OfType and Cast

`OfType` and `Cast` accept a nongeneric `IEnumerable` collection and emit a generic `IEnumerable<T>` sequence that you can subsequently query:

```

var classicList = new System.Collections.ArrayList();
classicList.AddRange ( new int[] { 3, 4, 5 } );
IEnumerable<int> sequence1 = classicList.Cast<int>();

```

This is useful because it allows you to query collections written prior to C# 2.0 (when `IEnumerable<T>` was introduced), such as `ControlCollection` in `System.Windows.Forms`.

`Cast` and `OfType` differ in their behavior when encountering an input element that's of an incompatible type: `Cast` throws an exception whereas `OfType` ignores the incompatible element.

The rules for element compatibility follow those of C#'s `is` operator. Here's the internal implementation of `Cast`:

```

public static IEnumerable<TSource> Cast <TSource>
    (IEnumerable source)
{
    foreach (object element in source)
        yield return (TSource)element;
}

```

C# supports the `Cast` operator in query expressions: simply insert the element type immediately after the `from` keyword:

```

from int x in classicList ...

```

This translates to:

```
from x in classicList.Cast <int>() ...
```

## Dynamic Binding (C# 4.0)

*Dynamic binding* defers *binding*—the process of resolving types, members, and operations—from compile time to runtime. Dynamic binding is useful when at compile time *you* know that a certain function, member, or operation exists, but the *compiler* does not. This commonly occurs when you are interoperating with dynamic languages (such as IronPython) and COM, and in scenarios when you might otherwise use reflection.

A dynamic type is declared with the contextual keyword `dynamic`:

```
dynamic d = GetSomeObject();
d.Quack();
```

A dynamic type tells the compiler to relax. We expect the runtime type of `d` to have a `Quack` method. We just can't prove it statically. Since `d` is dynamic, the compiler defers binding `Quack` to `d` until runtime. To understand what this means requires distinguishing between *static binding* and *dynamic binding*.

## Static Binding Versus Dynamic Binding

The canonical binding example is mapping a name to a specific function when compiling an expression. To compile the following expression, the compiler needs to find the implementation of the method named `Quack`:

```
d.Quack();
```

Let's suppose the static type of `d` is `Duck`:

```
Duck d = ...
d.Quack();
```

In the simplest case, the compiler does the binding by looking for a parameterless method named `Quack` on `Duck`. Failing that, the compiler extends its search to methods taking optional parameters, methods on base classes of `Duck`, and extension methods that take `Duck` as its first parameter. If no match is found, you'll get a compilation error. Regardless of what method gets bound, the bottom line is that the binding is done by the compiler, and the binding utterly depends on statically knowing the types of the operands (in this case, `d`). This makes it *static binding*.

Now let's change the static type of `d` to `object`:

```
object d = ...
d.Quack();
```

Calling `Quack` gives us a compilation error, because although the value stored in `d` can contain a method called `Quack`, the compiler cannot know it since the only information it has is the type of the variable, which in this case is `object`. But let's now change the static type of `d` to `dynamic`:

```
dynamic d = ...
d.Quack();
```

A `dynamic` type is like `object`—it's equally nondescriptive about a type. The difference is that it lets you use it in ways that aren't known at compile time. A `dynamic` object binds at runtime based on its runtime type, not its compile-time type. When the compiler sees a dynamically bound expression (which in general is an expression that contains any value of type `dynamic`), it merely packages up the expression such that the binding can be done later at runtime.

At runtime, if a `dynamic` object implements `IDynamicMetaObjectProvider`, that interface is used to perform the binding. If not, binding occurs in almost the same way as it would have had the compiler known the `dynamic` object's runtime type. These two alternatives are called *custom binding* and *language binding*.

## Custom Binding

Custom binding occurs when a dynamic object implements `IDynamicMetaObjectProvider` (IDMOP). Although you can implement IDMOP on types that you write in C#, and that is useful to do, the more common case is that you have acquired an IDMOP object from a dynamic language that is implemented in .NET on the Dynamic Language Runtime (DLR), such as IronPython or IronRuby. Objects from those languages implicitly implement IDMOP as a means to directly control the meanings of operations performed on them. Here's a simple example:

```
using System;
using System.Dynamic;

public class Test
{
    static void Main()
    {
        dynamic d = new Duck();
        d.Quack();    // Quack was called
        d.Waddle();  // Waddle was called
    }
}

public class Duck : DynamicObject
{
    public override bool TryInvokeMember (
        InvokeMemberBinder binder, object[] args,
        out object result)
    {
        Console.WriteLine (binder.Name + " was called");
        result = null;
        return true;
    }
}
```

The `Duck` class doesn't actually have a `Quack` method. Instead, it uses custom binding to intercept and interpret all method calls.

We discuss custom binders in greater detail in Chapter 19 of *C# 4.0 in a Nutshell* (O'Reilly).

## Language Binding

Language binding occurs when a dynamic object does not implement `IDynamicMetaObjectProvider`. Language binding is useful when working around imperfectly designed types or inherent limitations in the .NET type system. A typical problem with using numeric types is that they have no common interface. We have seen that methods can be bound dynamically; the same is true for operators:

```
static dynamic Mean (dynamic x, dynamic y)
{
    return (x + y) / 2;
}
static void Main()
{
    int x = 3, y = 4;
    Console.WriteLine (Mean (x, y));
}
```

The benefit is obvious—you don’t have to duplicate code for each numeric type. However, you lose static type safety, risking runtime exceptions rather than compile-time errors.

---

### NOTE

Dynamic binding circumvents static type safety, but not runtime type safety. Unlike with reflection, you cannot circumvent member accessibility rules with dynamic binding.

---

By design, language runtime binding behaves as similarly as possible to static binding, had the runtime types of the dynamic objects been known at compile time. In our previous example, the behavior of our program would be identical if we hardcoded `Mean` to work with the `int` type. The most notable exception in parity between static and dynamic binding is for extension methods, which we discuss in the section [“Uncallable Functions” on page 172](#).

---

**NOTE**

Dynamic binding also incurs a performance hit. Because of the DLR's caching mechanisms, however, repeated calls to the same dynamic expression are optimized—allowing you to efficiently call dynamic expressions in a loop. This optimization brings the typical overhead for a simple dynamic expression on today's hardware down to less than 100 ns.

---

## RuntimeBinderException

If a member fails to bind, a `RuntimeBinderException` is thrown. You can think of this like a compile-time error at runtime:

```
dynamic d = 5;
d.Hello(); // throws RuntimeBinderException
```

The exception is thrown because the `int` type has no `Hello` method.

## Runtime Representation of dynamic

There is a deep equivalence between the `dynamic` and `object` types. The runtime treats the following expression as true:

```
typeof (dynamic) == typeof (object)
```

This principle extends to constructed types and array types:

```
typeof (List<dynamic>) == typeof (List<object>)
typeof (dynamic[]) == typeof (object[])
```

Like an object reference, a `dynamic` reference can point to an object of any type (except pointer types):

```
dynamic x = "hello";
Console.WriteLine (x.GetType().Name); // String

x = 123; // No error (despite same variable)
Console.WriteLine (x.GetType().Name); // Int32
```

Structurally, there is no difference between an object reference and a `dynamic` reference. A `dynamic` reference simply enables

dynamic operations on the object it points to. You can convert from `object` to `dynamic` to perform any dynamic operation you want on an object:

```
object o = new System.Text.StringBuilder();
dynamic d = o;
d.Append ("hello");
Console.WriteLine (o);    // hello
```

## Dynamic Conversions

The `dynamic` type has implicit conversions to and from all other types. For a conversion to succeed, the runtime type of the dynamic object must be implicitly convertible to the target static type.

The following example throws a `RuntimeBinderException` because an `int` is not implicitly convertible to a `short`:

```
int i = 7;
dynamic d = i;
long l = d;    // OK - implicit conversion works
short j = d;   // throws RuntimeBinderException
```

## var Versus dynamic

The `var` and `dynamic` types bear a superficial resemblance, but the difference is deep:

`var` says, “Let the *compiler* figure out the type.”  
`dynamic` says, “Let the *runtime* figure out the type.”

To illustrate:

```
dynamic x = "hello"; // Static type is dynamic
var y = "hello";    // Static type is string
int i = x;          // Runtime error
int j = y;          // Compile-time error
```

## Dynamic Expressions

Fields, properties, methods, events, constructors, indexers, operators, and conversions can all be called dynamically.



Trying to consume the result of a dynamic expression with a `void` return type is prohibited—just as with a statically typed expression. The difference is that the error occurs at runtime.

Typically, expressions involving dynamic operands are themselves dynamic, since the effect of absent type information is cascading:

```
dynamic x = 2;
var y = x * 3;           // Static type of y is dynamic
```

There are a couple of obvious exceptions to this rule. First, casting a dynamic expression to a static type yields a static expression. Second, constructor invocations always yield static expressions—even when called with dynamic arguments.

In addition, there are a few edge cases where an expression containing a dynamic argument is static, including passing an index to an array and delegate-creation expressions.

## Dynamic Member Overload Resolution

The canonical use case for `dynamic` involves a dynamic *receiver*. This means that a dynamic object is the receiver of a dynamic function call:

```
dynamic x = ...;
x.Foo (123);           // x is the receiver
```

However, dynamic binding is not limited to receivers: the method arguments are also eligible for dynamic binding. The effect of calling a function with dynamic arguments is to defer overload resolution from compile time to runtime:

```
class Program
{
    static void Foo (int x)    { Console.WriteLine ("1"); }
    static void Foo (string x) { Console.WriteLine ("2"); }

    static void Main()
    {
        dynamic x = 5;
        dynamic y = "watermelon";
    }
}
```

```

        Foo (x);    // 1
        Foo (y);    // 2
    }
}

```

Runtime overload resolution is also called *multiple dispatch* and is useful in implementing design patterns such as *visitor*.

If a dynamic receiver is not involved, the compiler can statically perform a basic check to see whether the dynamic call will succeed: it checks that a function with the right name and number of parameters exists. If no candidate is found, you get a compile-time error.

If a function is called with a mixture of dynamic and static arguments, the final choice of method will reflect a mixture of dynamic and static binding decisions:

```

static void X(object x, object y) {Console.Write("oo");}
static void X(object x, string y) {Console.Write("os");}
static void X(string x, object y) {Console.Write("so");}
static void X(string x, string y) {Console.Write("ss");}

static void Main()
{
    object o = "hello";
    dynamic d = "goodbye";
    X (o, d);           // os
}

```

The call to `X(o,d)` is dynamically bound because one of its arguments, `d`, is *dynamic*. But since `o` is statically known, the binding—even though it occurs dynamically—will make use of that. In this case, overload resolution will pick the second implementation of `X` due to the static type of `o` and the runtime type of `d`. In other words, the compiler is “as static as it can possibly be.”

## Uncallable Functions

Some functions cannot be called dynamically. You cannot call:

- Extension methods (via extension method syntax)

- Any member of an interface (via the interface)
- Base members hidden by a subclass

This is because dynamic binding requires two pieces of information: the name of the function to call, and the object upon which to call the function. However, in each of the three uncallable scenarios, an *additional type* is involved, which is known only at compile time. As of C# 4.0, there's no way to specify these additional types dynamically.

When calling extension methods, that additional type is an extension class, chosen implicitly by virtue of `using` directives in your source code (which disappear after compilation). When calling members via an interface, the additional type is communicated via an implicit or explicit cast. (With explicit implementation, it's in fact impossible to call a member without casting to the interface.) A similar situation arises when calling a hidden base member: you must specify an additional type via either a cast or the `base` keyword—and that additional type is lost at runtime.

## Attributes

You're already familiar with the notion of attributing code elements of a program with modifiers, such as `virtual` or `ref`. These constructs are built into the language. *Attributes* are an extensible mechanism for adding custom information to code elements (assemblies, types, members, return values, and parameters). This extensibility is useful for services that integrate deeply into the type system, without requiring special keywords or constructs in the C# language.

A good scenario for attributes is serialization—the process of converting arbitrary objects to and from a particular format. In this scenario, an attribute on a field can specify the translation between C#'s representation of the field and the format's representation of the field.

## Attribute Classes

An attribute is defined by a class that inherits (directly or indirectly) from the abstract class `System.Attribute`. To attach an attribute to a code element, specify the attribute's type name in square brackets, before the code element. For example, the following attaches the `ObsoleteAttribute` to the `Foo` class:

```
[ObsoleteAttribute]
public class Foo {...}
```

This attribute is recognized by the compiler and will cause compiler warnings if a type or member marked obsolete is referenced. By convention, all attribute types end in the word *Attribute*. `C#` recognizes this and allows you to omit the suffix when attaching an attribute:

```
[Obsolete]
public class Foo {...}
```

`ObsoleteAttribute` is a type declared in the `System` namespace as follows (simplified for brevity):

```
public sealed class ObsoleteAttribute : Attribute {...}
```

## Named and Positional Attribute Parameters

Attributes may have parameters. In the following example, we apply `XmlElementAttribute` to a class. This attribute tells XML serializer (in `System.Xml.Serialization`) how an object is represented in XML and accepts several *attribute parameters*. The following attribute maps the `CustomerEntity` class to an XML element named `Customer`, belonging to the <http://oreilly.com> namespace:

```
[XmlElement ("Customer", Namespace="http://oreilly.com")]
public class CustomerEntity { ... }
```

Attribute parameters fall into one of two categories: positional or named. In the preceding example, the first argument is a *positional parameter*; the second is a *named parameter*. Positional parameters correspond to parameters of the attribute

type's public constructors. Named parameters correspond to public fields or public properties on the attribute type.

When specifying an attribute, you must include positional parameters that correspond to one of the attribute's constructors. Named parameters are optional.

## Attribute Targets

Implicitly, the target of an attribute is the code element it immediately precedes, which is typically a type or type member. You can also attach attributes, however, to an assembly. This requires that you explicitly specify the attribute's target.

Here is an example of using the `CLSCompliant` attribute to specify Common Language Specification (CLS) compliance for an entire assembly:

```
[assembly:CLSCompliant(true)]
```

## Specifying Multiple Attributes

Multiple attributes can be specified for a single code element. Each attribute can be listed either within the same pair of square brackets (separated by a comma) or in separate pairs of square brackets (or a combination of the two). The following two examples are semantically identical:

```
[Serializable, Obsolete, CLSCompliant(false)]
public class Bar {...}
```

```
[Serializable] [Obsolete] [CLSCompliant(false)]
public class Bar {...}
```

## Writing Custom Attributes

You can define your own attributes by subclassing `System.Attribute`. For example, we could use the following custom attribute for flagging a method for unit testing:

```
[AttributeUsage (AttributeTargets.Method)]
public sealed class TestAttribute : Attribute
{
    public int    Repetitions;
    public string FailureMessage;

    public TestAttribute () : this (1) { }
    public TestAttribute (int repetitions)
    {
        Repetitions = repetitions;
    }
}
```

Here's how we could apply the attribute:

```
class Foo
{
    [Test]
    public void Method1() { ... }

    [Test(20)]
    public void Method2() { ... }

    [Test(20, FailureMessage="Debugging Time!")]
    public void Method3() { ... }
}
```

`AttributeUsage` is itself an attribute that indicates the construct (or combination of constructs) that the custom attribute can be applied to. The `AttributeTargets` enum includes such members as `Class`, `Method`, `Parameter`, `Constructor` (and `All`, which combines all targets).

## Retrieving Attributes at Runtime

There are two standard ways to retrieve attributes at runtime:

- Call `GetCustomAttributes` on any `Type` or `MemberInfo` object.
- Call `Attribute.GetCustomAttribute` or `Attribute.GetCustomAttributes`.

These latter two methods are overloaded to accept any reflection object that corresponds to a valid attribute target (`Type`, `Assembly`, `Module`, `MemberInfo`, or `ParameterInfo`).

Here's how we can enumerate each method in the preceding `Foo` class that has a `TestAttribute`:

```
foreach (MethodInfo mi in typeof (Foo).GetMethods())
{
    TestAttribute att = (TestAttribute)
        Attribute.GetCustomAttribute
            (mi, typeof (TestAttribute));

    if (att != null)
        Console.WriteLine (
            "Method {0} will be tested; reps={1}; msg={2}",
            mi.Name, att.Repetitions, att.FailureMessage);
}
```

Here's the output:

```
Method Method1 will be tested; reps=1; msg=
Method Method2 will be tested; reps=20; msg=
Method Method3 will be tested; reps=20; msg=Debugging Time!
```

## Unsafe Code and Pointers

C# supports direct memory manipulation via pointers within blocks of code marked unsafe and compiled with the `/unsafe` compiler option. Pointer types are primarily useful for interoperability with C APIs, but may also be used for accessing memory outside the managed heap or for performance-critical hotspots.

### Pointer Basics

For every value type or pointer type  $V$ , there is a corresponding pointer type  $V^*$ . A pointer instance holds the address of a value. This is considered to be of type  $V$ , but pointer types can be (unsafely) cast to any other pointer type. The main pointer operators are:

Operator	Meaning
&	The <i>address-of</i> operator returns a pointer to the address of a value.
*	The <i>dereference</i> operator returns the value at the address of a pointer.
->	The <i>pointer-to-member</i> operator is a syntactic shortcut, in which <code>x-&gt;y</code> is equivalent to <code>(*x).y</code> .

## Unsafe Code

By marking a type, type member, or statement block with the `unsafe` keyword, you're permitted to use pointer types and perform C++ style pointer operations on memory within that scope. Here is an example of using pointers to quickly process a bitmap:

```
unsafe void BlueFilter (int[,] bitmap)
{
    int length = bitmap.Length;
    fixed (int* b = bitmap)
    {
        int* p = b;
        for (int i = 0; i < length; i++)
            *p++ &= 0xFF;
    }
}
```

Unsafe code can run faster than a corresponding safe implementation. In this case, the code would have required a nested loop with array indexing and bounds checking. An unsafe C# method may also be faster than calling an external C function, since there is no overhead associated with leaving the managed execution environment.

## The fixed Statement

The `fixed` statement is required to pin a managed object, such as the bitmap in the previous example. During the execution of a program, many objects are allocated and deallocated from the heap. In order to avoid unnecessary waste or fragmentation of memory, the garbage collector moves objects around. Pointing to an object is futile if its address could change while



referencing it, so the `fixed` statement tells the garbage collector to “pin” the object and not move it around. This may have an impact on the efficiency of the runtime, so `fixed` blocks should be used only briefly, and heap allocation should be avoided within the `fixed` block.

Within a `fixed` statement, you can get a pointer to any value type, an array of value types, or a string. In the case of arrays and strings, the pointer will actually point to the first element, which is a value type.

Value types declared inline within reference types require the reference type to be pinned, as follows:

```
class Test
{
    int x;
    unsafe static void Main()
    {
        Test test = new Test();
        fixed (int* p = &test.x)    // Pins test
        {
            *p = 9;
        }
        System.Console.WriteLine (test.x);
    }
}
```

## The Pointer-to-Member Operator

In addition to the `&` and `*` operators, C# also provides the C++ style `->` operator, which can be used on structs:

```
struct Test
{
    int x;
    unsafe static void Main()
    {
        Test test = new Test();
        Test* p = &test;
        p->x = 9;
        System.Console.WriteLine (test.x);
    }
}
```

## Arrays

### The `stackalloc` keyword

Memory can be allocated in a block on the stack explicitly using the `stackalloc` keyword. Since it is allocated on the stack, its lifetime is limited to the execution of the method, just as with any other local variable. The block may use the `[]` operator to index into memory:

```
int* a = stackalloc int [10];
for (int i = 0; i < 10; ++i)
    Console.WriteLine (a[i]); // Print raw memory
```

### Fixed-size buffers

Memory can be allocated in a block within a struct using the `fixed` keyword:

```
unsafe struct UnsafeUnicodeString
{
    public short Length;
    public fixed byte Buffer[30];
}

unsafe class UnsafeClass
{
    UnsafeUnicodeString uus;

    public UnsafeClass (string s)
    {
        uus.Length = (short)s.Length;
        fixed (byte* p = uus.Buffer)
            for (int i = 0; i < s.Length; i++)
                p[i] = (byte) s[i];
    }
}
```

The `fixed` keyword is also used in this example to pin the object on the heap that contains the buffer (which will be the instance of `UnsafeClass`).

## void\*

A *void pointer* (`void*`) makes no assumptions about the type of the underlying data and is useful for functions that deal with raw memory. An implicit conversion exists from any pointer type to `void*`. A `void*` cannot be dereferenced, and arithmetic operations cannot be performed on void pointers. For example:

```
class Test
{
    unsafe static void Main()
    {
        short[] a = {1,1,2,3,5,8,13,21,34,55};
        fixed (short* p = a)
        {
            //sizeof returns size of value-type in bytes
            Zap (p, a.Length * sizeof (short));
        }
        foreach (short x in a)
            System.Console.WriteLine (x); // Prints all zeros
    }

    unsafe static void Zap (void* memory, int byteCount)
    {
        byte* b = (byte*) memory;
        for (int i = 0; i < byteCount; i++)
            *b++ = 0;
    }
}
```

## Pointers to Unmanaged Code

Pointers are also useful for accessing data outside the managed heap (such as when interacting with C DLLs or COM), or when dealing with data not in the main memory (such as graphics memory or a storage medium on an embedded device).

## Preprocessor Directives

Preprocessor directives supply the compiler with additional information about regions of code. The most common preprocessor directives are the conditional directives, which provide a way to include or exclude regions of code from compilation. For example:

```
#define DEBUG
class MyClass
{
    int x;
    void Foo()
    {
        # if DEBUG
        Console.WriteLine ("Testing: x = {0}", x);
        # endif
    }
    ...
}
```

In this class, the statement in `Foo` is compiled as conditionally dependent upon the presence of the `DEBUG` symbol. If we remove the `DEBUG` symbol, the statement is not compiled. Preprocessor symbols can be defined within a source file (as we have done), and they can be passed to the compiler with the `/define:symbol` command-line option.

With the `#if` and `#elif` directives, you can use the `||`, `&&`, and `!` operators to perform *or*, *and*, and *not* operations on multiple symbols. The following directive instructs the compiler to include the code that follows if the `TESTMODE` symbol is defined and the `DEBUG` symbol is not defined:

```
#if TESTMODE && !DEBUG
...

```

Bear in mind, however, that you're not building an ordinary C# expression, and the symbols upon which you operate have absolutely no connection to *variables*—static or otherwise.

The `#error` and `#warning` symbols prevent accidental misuse of conditional directives by making the compiler generate a warning or error given an undesirable set of compilation symbols.

Here's a complete list of preprocessor directives:

Preprocessor directive	Action
<code>#define symbol</code>	Defines <i>symbol</i>
<code>#undef symbol</code>	Undefines <i>symbol</i>
<code>#if symbol [operator symbol2]...</code>	<i>symbol</i> to test <i>operators</i> are ==, !=, &&, and     followed by #else, #elif, and #endif
<code>#else</code>	Executes code to subsequent #endif
<code>#elif symbol [operator symbol2]</code>	Combines #else branch and #if test
<code>#endif</code>	Ends conditional directives
<code>#warning text</code>	<i>text</i> of the warning to appear in compiler output
<code>#error text</code>	<i>text</i> of the error to appear in com- piler output
<code>#line [number ["file"]   hidden]</code>	<i>number</i> specifies the line in source code; <i>file</i> is the filename to appear in computer output; <i>hidden</i> in- structs debuggers to skip over code from this point until the next #line directive
<code>#region name</code>	Marks the beginning of an outline
<code>#endregion</code>	Ends an outline region
<code>#pragma warning</code>	See below

## Pragma Warning

The compiler generates a warning when it spots something in your code that seems unintentional. Unlike errors, warnings don't ordinarily prevent your application from compiling.

Compiler warnings can be extremely valuable in spotting bugs. Their usefulness, however, is undermined when you get *false*

warnings. In a large application, maintaining a good signal-to-noise ratio is essential if the “real” warnings are to get noticed.

To this effect, the compiler allows you to selectively suppress warnings with the `#pragma warning` directive. In this example, we instruct the compiler not to warn us about the field `Message` not being used:

```
public class Foo
{
    static void Main() { }

    #pragma warning disable 414
    static string Message = "Hello";
    #pragma warning restore 414
}
```

Omitting the number in the `#pragma warning` directive disables or restores all warning codes.

If you are thorough in applying this directive, you can compile with the `/warnaserror` switch—this tells the compiler to treat any residual warnings as errors.

## XML Documentation

A *documentation comment* is a piece of embedded XML that documents a type or member. A documentation comment comes immediately before a type or member declaration, and starts with three slashes:

```
/// <summary>Cancels a running query.</summary>
public void Cancel() { ... }
```

Multiline comments can be done either like this:

```
/// <summary>
/// Cancels a running query
/// </summary>
public void Cancel() { ... }
```

or like this (notice the extra star at the start):

```
/**
  <summary> Cancels a running query. </summary>
 */
public void Cancel() { ... }
```

If you compile with the `/doc` directive, the compiler extracts and collates documentation comments into a single XML file. This has two main uses:

- If placed in the same folder as the compiled assembly, Visual Studio automatically reads the XML file and uses the information to provide IntelliSense member listings to consumers of the assembly of the same name.
- Third-party tools (such as Sandcastle and NDoc) can transform an XML file into an HTML help file.

## Standard XML Documentation Tags

Here are the standard XML tags that Visual Studio and documentation generators recognize:

```
<summary>
  <summary>...</summary>
```

Indicates the tool tip that IntelliSense should display for the type or member. Typically a single phrase or sentence.

```
<remarks>
  <remarks>...</remarks>
```

Additional text that describes the type or member. Documentation generators pick this up and merge it into the bulk of a type or member's description.

```
<param>
  <param name="name">...</param>
```

Explains a parameter on a method.

```
<returns>
  <returns>...</returns>
```

Explains the return value for a method.

**<exception>**

```
<exception [cref="type"]>...</exception>
```

Lists an exception that a method may throw (cref refers to the exception type).

**<permission>**

```
<permission [cref="type"]>...</permission>
```

Indicates an `IPermission` type required by the documented type or member.

**<example>**

```
<example>...</example>
```

Denotes an example (used by documentation generators). This usually contains both description text and source code (source code is typically within a `<c>` or `<code>` tags).

**<c>**

```
<c>...</c>
```

Indicates an inline code snippet. This tag is usually used inside an `<example>` block.

**<code>**

```
<code>...</code>
```

Indicates a multiline code sample. This tag is usually used inside an `<example>` block.

**<see>**

```
<see cref="member">...</see>
```

Inserts an inline cross-reference to another type or member. HTML documentation generators typically convert this to a hyperlink. The compiler emits a warning if the type or member name is invalid.



`<seealso>`

```
<seealso cref="member">...</seealso>
```

Cross-references another type or member. Documentation generators typically write this into a separate “See Also” section at the bottom of the page.

`<paramref>`

```
<paramref name="name"/>
```

References a parameter from within a `<summary>` or `<remarks>` tag.

`<list>`

```
<list type=[ bullet | number | table ]>
  <listheader>
    <term>...</term>
    <description>...</description>
  </listheader>
  <item>
    <term>...</term>
    <description>...</description>
  </item>
</list>
```

Instructs documentation generators to emit a bulleted, numbered, or table-style list.

`<para>`

```
<para>...</para>
```

Instructs documentation generators to format the contents into a separate paragraph.

`<include>`

Merges an external XML file that contains documentation. The path attribute denotes an XPath query to a specific element in that file.

Download from Library of Wow! eBook  
<www.wowebook.com>



# Index

## Symbols

- & (ampersand)
  - address-of pointer operator, 46, 178
  - bitwise and operator, 23
  - logical and operator, 47
  - && conditional and operator, 27, 47
- \* (asterisk)
  - dereference pointer operator, 46, 178
  - multiply operator, 46
- @ (at-sign)
  - prefixing identifiers
- \ (backslash)
  - escape sequence for, 28
  - preceding escape sequences, 28
- { } (braces)
  - enclosing statement blocks, 9, 48
- ^ (caret)
  - bitwise exclusive or operator, 23
  - logical exclusive or operator, 47
- " (double quote)
  - escape sequence for, 28
- = (equal sign)
  - assignment operator, 43, 47
  - == equal to operator, 26, 47
  - => lambda operator, 48
- ! (exclamation point)
  - not operator, 27, 46
  - != not equal to operator, 26, 47
- / (forward slash)
  - divide operator, 46
  - /\*\*/ enclosing multiline comments, 10
  - // preceding comments, 3, 10
- < (left angle bracket)

We'd like to hear your suggestions for improving our indexes. Send email to [index@oreilly.com](mailto:index@oreilly.com).

- less than operator, 26, 46
  - `<=` less than or equal to operator, 26, 46
  - `<<` shift left operator, 23, 46
  - (minus sign)
    - negative value, 46
    - removing delegate operands, 102
    - subtract operator, 46
  - `--` decrement operator, 22, 45, 46
  - `->` pointer-to-member operator, 45, 178, 179
  - `-=` removing delegate operands, 102, 111
  - () (parentheses)
    - cast operator, 46
    - grouping in expressions, 45
    - method call or declaration, 9, 45
  - % (percent sign)
    - remainder operator, 22, 46
  - . (period)
    - member access, 45
  - + (plus sign)
    - add operator, 46
    - combining delegates, 102
    - concatenation operator, 30
    - positive value, 46
    - `+=` combining delegates, 102, 111
    - `++` increment operator, 22, 45, 46
  - ? (question mark)
    - indicating nullable types, 131
    - `??` null coalescing operator, 134
    - `?:` ternary conditional operator, 27, 47
  - > (right angle bracket)
    - greater than operator, 26, 46
    - `>=` greater than or equal to operator, 26, 46
    - `>>` shift right operator, 23, 46
  - ;(semicolon)
    - terminating statements, 4, 9
  - ' (single quote)
    - escape sequence for, 28
  - [] (square brackets)
    - array declaration or index, 31, 45
    - enclosing attributes, 174
    - indexer declaration, 66
  - ~ (tilde)
    - bitwise complement operator, 23, 46
    - finalizers, 68
  - | (vertical bar)
    - bitwise or operator, 23
    - logical or operator, 47
    - `||` conditional or operator, 27, 47
  - 8-bit integral types, 24
  - 16-bit integral types, 24
- ## A
- abstract classes, 74

- abstract members, 74, 87
  - access modifiers, 83–85
  - accessibility capping, 84
  - accessors, 64, 65
  - Action delegates, 103
  - add operator (+), 46
  - address-of pointer operator (&), 46, 178
  - Aggregate operator, LINQ, 150
  - aggregation operators, LINQ, 144, 147, 150
  - alert, escape sequence for, 28
  - aliasing namespaces, 59
  - All operator, LINQ, 145, 150
  - ampersand (&)
    - address-of pointer operator, 46, 178
    - bitwise and operator, 23
    - logical and operator, 47
    - && conditional and operator, 27, 47
  - and operator, bitwise (&), 23
  - and operator, conditional (&&), 27, 47
  - and operator, logical (&), 47
  - anonymous methods, 116–117
  - anonymous types, 140
  - Any operator, LINQ, 145, 150
  - ArgumentException class, 123
  - ArgumentNullException class, 124
  - ArgumentOutOfRangeException class, 124
  - arguments, 5, 37–42, 37
    - (see also parameters)
  - arithmetic operators, 22, 46
  - arrays, 31–35
    - allocating to stack, 180
    - allocating within a struct, 180
    - default initialization, 32
    - initialization expressions, 34
    - multidimensional, 33
  - as operator, 47, 72
  - AsEnumerable operator, LINQ, 151
  - AsQueryable operator, LINQ, 151
  - assemblies, 6
  - assignment expressions, 43
  - assignment operators, 43, 45, 47
  - assignment, definite, 36
  - associativity of operators, 44
  - asterisk (\*)
    - dereference pointer operator, 46, 178
    - multiply operator, 46
  - at-sign (@)
    - prefixing identifiers, 8
  - attributes, 173–177
  - automatic properties, 65
  - Average operator, LINQ, 144, 150
- ## B
- backslash (\)
    - escape sequence for, 28
    - preceding escape sequences, 28

- backspace, escape sequence for, 28
  - base class constraints, 96
  - base keyword, 75, 76
  - binary operators, 43
  - BinarySearch method, arrays, 32
  - binding
    - custom binding, 167
    - dynamic binding, 165–173
    - language binding, 168–169
    - static binding, 165
  - bitwise and operator (&), 23
  - bitwise complement operator (~), 23, 46
  - bitwise exclusive or operator (^), 23
  - bitwise operators, 23, 46
  - bitwise or operator (|), 23
  - bool type, 11, 26
  - boolean operators, 26–27
  - boxing, 79–80, 132
  - braces ({}), enclosing statement blocks, 9, 48
  - break statement, 51, 54
  - built-in types (see predefined types)
  - byte type, 19, 24
- C**
- <c> XML tag, 186
  - camel case, 7
  - captured variables, 114–116
  - caret (^)
  - bitwise exclusive or operator, 23
  - logical exclusive or operator, 47
  - carriage return, escape sequence for, 28
  - case
    - of identifiers, 7
    - of strings, 31
  - cast operator (()), 46
  - Cast operator, LINQ, 150, 164
  - casting, 14, 71–73, 150, 164 (see also conversions)
  - catch block, 117, 119–120
  - chaining extension methods, 139
  - char literal, 28
  - char type, 28
  - checked operator, 23, 45
  - class constraint, 96
  - classes, 5, 59–70
    - abstract classes, 74
    - attribute classes, 174
    - sealing, 75
    - static classes, 68
  - closure, 114
  - <code> XML tag, 186
  - collection initializers, 126
  - collections, querying (see LINQ)
  - comments, 3, 10, 184–187
  - CompareTo method, 30
  - comparison of strings, 30
  - comparison operators, 26, 136
  - compilation, 6, 182–183
  - complement operator (~), 23

- compound assignment operators, 44, 135
  - Concat operator, LINQ, 145, 149
  - concatenation of strings, 30
  - conditional compilation, 182
  - conditional operators, 27, 47
  - conditional ternary operator (?:), 27, 47
  - Console class, 5
  - constants, 66
  - constraints for generics, 95
  - constructors, 13
    - inheritance of, 76
    - instance constructors, 61–62
    - static constructors, 67
  - Contains method, strings, 30
  - Contains operator, LINQ, 145, 150
  - contextual keywords, 9
  - continue statement, 54
  - contravariance (delegates), 105
  - contravariance (interfaces), 99
  - conversions, 14, 164
    - (see also casting)
    - boxing and unboxing, 79–80, 132
    - char to numeric, 29
    - downcasting, 72
    - with dynamic types, 170
    - explicit conversions, 14, 21, 137
    - implicit conversions, 14, 21, 24, 137
    - with integral types, 21, 24
    - in LINQ queries, 146, 148, 150
    - with nullable types, 131
    - with numeric types, 21
    - overloading, 137
    - with real types, 21
    - reference conversions, 71
    - upcasting, 71
  - Copy method, arrays, 32
  - Count operator, LINQ, 144, 150
  - covariance (delegates), 105
  - covariance (interfaces), 98
  - CreateInstance method, arrays, 32
  - .cs file extension (source file), 6
  - csc.exe file (compiler), 6
  - custom binding, 167
  - custom types, 11–14
- ## D
- D suffix, numeric literals, 20
  - data members of types, 12
  - decimal type, 19, 25
  - declaration statements, 48
  - decrement operator (--), 22, 45, 46
  - default keyword, 37, 95
  - default values, 37
  - DefaultIfEmpty operator, LINQ, 150
  - #define directive, 183
  - definite assignment, 36
  - delegates, 100–106, 112
  - dereference pointer operator (\*), 46, 178

- derived classes (see subclasses)
  - destructors (see finalizers)
  - Distinct operator, LINQ, 148
  - divide operator (/), 46
  - division by zero, 22
  - division, integral, 22
  - .dll file extension (library), 6
  - do-while loops, 52
  - documentation comments, 184–187
  - double quote (")
    - escape sequence for, 28
  - double type, 19, 24, 25
  - downcasting, 72
  - dynamic binding, 165–173
  - dynamic expressions, 170
  - dynamic type, 165, 170
- E**
- element operators, LINQ, 144, 147, 149
  - ElementAt operator, LINQ, 144, 150
  - ElementAtOrDefault operator, LINQ, 144, 150
  - elements, LINQ, 141
  - #elif directive, 182, 183
  - else clause, 49
  - #else directive, 183
  - Empty operator, LINQ, 151
  - encapsulation, 14
  - #endif directive, 183
  - #endregion directive, 183
  - EndsWith method, strings, 30
  - enumerators, 125–129
  - enums, 88–91
  - equal sign (=)
    - assignment operator, 43, 47
    - == equal to operator, 26, 47
    - => lambda operator, 48
  - equal to operator (==), 26, 47
  - equality operators, 26, 47, 133, 136
  - Equals method, object class, 81
  - #error directive, 182, 183
  - escape sequences, 28
  - event keyword, 107
  - EventArgs class, 109
  - events, 107–112
  - <example> XML tag, 186
  - Except operator, LINQ, 145, 149
  - Exception class, 123
  - <exception> XML tag, 186
  - exceptions, 117–124
    - catching, 119–120
    - division by zero, 22
    - integral overflow, 23
    - throwing, 122–123
    - types, list of, 123
  - exclamation point (!)
    - not operator, 27, 46
    - != not equal to operator, 26, 47
  - exclusive or operator, logical (^), 47
  - .exe file extension (application), 6
  - explicit conversions, 14, 21, 137



explicit interface  
 implementation, 86  
 expression statements, 48  
 expression tree, 112  
 expressions, 43–48, 170  
 extension methods, 138–139

## F

F suffix, numeric literals, 20  
 false boolean value, 11  
 fields, 59  
 filtering operators, LINQ,  
 147, 148  
 finalizers, 68  
 finally block, 117, 120–121  
 Find method, arrays, 32  
 FindIndex method, arrays, 32  
 FindLastIndex method,  
 arrays, 32  
 First operator, LINQ, 144,  
 149  
 FirstOrDefault operator,  
 LINQ, 144, 149  
 fixed keyword, 180  
 fixed statement, 178  
 Flags attribute, enums, 90  
 float type, 19, 24  
 fluent queries, LINQ, 152,  
 154  
 for loops, 53  
 foreach loops, 53, 125  
 form feed, escape sequence  
 for, 28  
 forward slash (/)  
 divide operator, 46  
`/**` enclosing multi-line  
 comments, 10

`//` preceding comments, 3,  
 10  
 friend assemblies, 84  
 from clause, query  
 expressions, 153  
 Func delegates, 103  
 function members of types,  
 12  
 functions, 5  
 (see also methods)  
 calling dynamically, ability  
 to, 172  
 sealing, 75  
 types of, 5  
 virtual functions, 73

## G

garbage collection, 36  
 generic delegate types, 103  
 generic methods, 93  
 generic type constraints, 95  
 generic types, 92  
 generics, 92–100  
 get accessors, 64, 65  
 GetHashCode method, object  
 class, 82  
 GetType method, object class,  
 80  
 GetValue method, arrays, 32  
 global:: qualifier, 58  
 goto case statement, 51  
 goto default statement, 51  
 goto statement, 55  
 greater than operator (>), 26,  
 46  
 greater than or equal to  
 operator (>=), 26, 46

group clause, query expressions, 153  
 GroupBy operator, LINQ, 149, 162–164  
 grouping operators, LINQ, 147, 149  
 GroupJoin operator, LINQ, 149, 160

## H

heap, 36  
 hexadecimal literals, 20  
 hiding inherited members, 74  
 horizontal tab, escape sequence for, 28

## I

identifiers, 7–9  
 #if directive, 182, 183  
 if statement, 49–50  
 implicit conversions, 14, 21, 137  
 implicitly typed local variables, 42  
 <include> XML tag, 187  
 increment operator (++), 22, 45, 46  
 indexers, 65–66  
 IndexOf method, arrays, 32  
 IndexOf method, strings, 30  
 IndexOutOfRangeException class, 32  
 infinity, special values for, 24  
 inheritance, 70–78  
 initializing objects, 62  
 InnerException property, System.Exception, 123  
 Insert method, strings, 31

instance constructors, 61–62  
 instance members of types, 13  
 instance methods, 139  
 int type, 10, 19  
 integral literals, 20  
 integral types, 19  
   8-bit and 16-bit, 24  
   conversions involving, 21, 24  
   division on, 22  
   overflow of, 22  
 interfaces, 85–88  
 internal access level, 65  
 internal modifier, 83  
 Intersect operator, LINQ, 145, 149  
 into keyword, LINQ, 156  
 InvalidOperationException class, 124  
 is operator, 46, 73  
 iteration statements, 52–54  
 iteration variables, capturing, 115  
 iterators, 126–129

## J

jagged arrays, 34  
 Join method, strings, 31  
 Join operator, LINQ, 149, 159  
 joining operators, LINQ, 147, 149, 158–161  
 jump statements, 51, 54–55

## K

keywords, 7–9

**L**

- L suffix, numeric literals, 20
- lambda expressions, 112–116, 143
- lambda operator (`=>`), 48
- language binding, 168–169
- Last operator, LINQ, 144, 149
- LastIndexOf method, arrays, 32
- LastIndexOf method, strings, 30
- LastOrDefault operator, LINQ, 144, 149
- left angle bracket (`<`)
  - less than operator, 26, 46
  - `<=` less than or equal to operator, 26, 46
  - `<<` shift left operator, 23, 46
- left-associative operators, 44
- Length property, arrays, 32
- less than operator (`<`), 26, 46
- less than or equal to operator (`<=`), 26, 46
- let keyword, LINQ, 155–156
- libraries, 6
- `#line` directive, 183
- LINQ (Language Integrated Query), 140–165
  - aggregation operators, 144
  - Cast operator, 164
  - chaining query operators, 151
  - conversion operators, 146
  - deferred execution, 145–147
  - elements, 141
  - fluent queries, 152, 154
  - grouping, 162–164
  - joining operators, 158–161
  - let keyword, 155–156
  - multiple generators, 157–158
  - namespace for, 142
  - OfType operator, 164
  - ordering of input
    - sequence, 143
  - ordering of results, 161–162
  - projecting, 143
  - quantifiers, 145
  - query continuations, 156
  - query expressions, 152–155
  - query operators, 141, 147–151
  - query syntax, 142
  - sequences, 141
  - set operators, 145
  - subqueries, 147
- LINQPad, 141
- `<list>` XML tag, 187
- literals, 5, 9, 20
- local variables, 4, 42, 48
- logical operators, 47
- long type, 19
- LongCount operator, LINQ, 150
- loops (see iteration statements)

**M**

M suffix, numeric literals, 20  
 Main method, 5  
 Max operator, LINQ, 144, 150  
 Message property,  
     System.Exception, 123  
 methods, 4–5, 60–62  
     (see also functions;  
     parameters)  
     anonymous methods,  
         116–117  
     arguments for, 5  
     extension methods, 138–  
         139  
     generic methods, 93  
     instance methods, 139  
 Main method, 5  
 overloading, 60, 77  
 partial methods, 69  
 plug-in methods with  
     delegates, 101  
 return type for, 4  
 return values of, 40  
 virtual methods, 73  
 Min operator, LINQ, 144, 150  
 minus sign (-)  
     negative value, 46  
     removing delegate  
         operands, 102  
     subtract operator, 46  
     -- decrement operator, 22,  
         45, 46  
     -> pointer-to-member  
         operator, 45, 178,  
         179

    -= removing delegate  
         operands, 102, 111  
 modulus (remainder)  
     operator (%), 22  
 multicast delegates, 102  
 multidimensional arrays, 33–  
     34  
 multiple dispatch, 172  
 multiple generators, LINQ,  
     157–158  
 multiply operator (\*), 46

**N**

naked type constraint, 96  
 named parameters of  
     attributes, 174  
 named parameters of  
     methods, 41  
 namespace keyword, 56  
 namespaces, 5, 55–59  
 NaN (Not a Number) value,  
     24  
 negative zero, 24  
 nested types, 91  
 .NET Framework  
     libraries in, 6  
     namespaces in, 6  
 new keyword, 13, 45, 140  
 new line, escape sequence for,  
     28  
 new modifier, 75  
 nonpublic constructors, 62  
 Not a Number (NaN) value,  
     24  
 not equal to operator (!=), 26,  
     47  
 not operator (!), 27, 46

NotImplementedException  
     class, 124  
 NotSupportedException  
     class, 124  
 null coalescing operator (??),  
     134  
 null value, 17  
 null, escape sequence for, 28  
 nullable types, 130–135  
 Nullable<T> struct, 131  
 numeric literals, 20  
 numeric suffixes, 20  
 numeric types, 19–25

## O

object initializers, 62  
 object type, 78–82  
 ObjectDisposedException  
     class, 124  
 ObsoleteAttribute class, 174  
 OfType operator, LINQ, 150,  
     164  
 operator functions, 135  
 operator keyword, 135  
 operators, 9, 43–48  
     arithmetic operators, 22,  
         46  
     assignment operators, 43,  
         45, 47  
     associativity of, 44  
     bitwise operators, 23, 46  
     boolean operators, 26–27  
     checked and unchecked,  
         23  
     comparison operators, 26,  
         136  
     conditional operators, 27,  
         47

    equality operators, 26, 47,  
         133, 136  
     increment and decrement,  
         22, 45, 46  
     lifting, for nullable types,  
         132–134  
     LINQ query operators,  
         141, 147–151  
     logical operators, 47  
     overloading, 135–138  
     precedence of, 44  
     relational operators, 46,  
         133  
 optional parameters, 40  
 or operator, bitwise (|), 23  
 or operator, conditional (||),  
     27, 47  
 or operator, logical (||), 47  
 orderby keyword, LINQ,  
     161–162  
 OrderBy operator, LINQ,  
     149  
 OrderByDescending  
     operator, LINQ, 149  
 ordering operators, LINQ,  
     147, 149  
 out modifier, 38, 39  
 outer variables, capturing,  
     114  
 overflow, integral, 22  
 overloading constructors, 61  
 overloading methods, 60, 77  
 overloading operators, 135–  
     138  
 override modifier, 73

## P

PadLeft method, strings, 31

- PadRight method, strings, 31
- <para> XML tag, 187
- <param> XML tag, 185
- parameter variance, delegates, 105
- parameterless constructor constraint, 96
- parameterless constructors, 61
- parameters
  - of attributes, 174
  - of generics, 94
  - of methods, 37–42
- parameters of methods, 4
- <paramref> XML tag, 187
- params modifier, 40
- parentheses ()
  - cast operator, 46
  - grouping in expressions, 45
  - method call or declaration, 9, 45
- partial methods, 69
- partial types, 68–70
- Pascal case, 7
- passing arguments
  - by reference, 39
  - by value, 38
- percent sign (%)
  - remainder operator, 22, 46
- period (.)
  - member access, 45
- <permission> XML tag, 186
- pinning objects, 178
- plug-in methods with delegates, 101
- plus sign (+)
  - add operator, 46
  - combining delegates, 102
  - concatenation operator, 30
  - positive value, 46
  - += combining delegates, 102, 111
  - ++ increment operator, 22, 45, 46
- pointer-to-member operator (->), 45, 178, 179
- pointers, 177–181
- polymorphism, 71
- positional parameters of attributes, 174
- #pragma warning directive, 183
- precedence of operators, 44
- predefined (built-in) types, 10, 12, 18
- preprocessor directives, 182–184
- primary operators, 43
- primitive types, 19
- private access level, 65
- private modifier with property accessors, 83
- projecting, LINQ, 143, 147, 148
- properties, 63–65
- protected internal modifier, 84
- protected modifier, 84
- public keyword, 14
- public modifier, 83
- punctuators, 9

**Q**

- quantifiers, LINQ, 145, 148, 150
- query continuations, LINQ, 156
- query expressions, LINQ, 152–155
- query operators, LINQ, 141, 147–151
- querying collections (see LINQ)
- question mark (?)
  - indicating nullable types, 131
  - ?? null coalescing operator, 134
  - ?: ternary conditional operator, 27, 47

**R**

- Range operator, LINQ, 151
- readonly field modifier, 60
- real literals, 20
- real types, 19
  - conversions involving, 21
  - rounding errors with, 25
  - special values for, 24
- rectangular arrays, 33
- ref modifier, 38, 39
- reference conversions, 71
- reference types, 15, 16, 18
- ReferenceEquals method, object class, 82
- #region directive, 183
- relational operators, 46, 133
- remainder operator (%), 22, 46

- remainders, of integral division, 22
  - <remarks> XML tag, 185
  - Remove method, strings, 31
  - Repeat operator, LINQ, 151
  - return statement, 55
  - return type for methods, 4
  - return type variance, delegates, 105
  - return values of methods, 40
  - <returns> XML tag, 185
  - Reverse operator, LINQ, 143, 149
  - right angle bracket (>)
    - greater than operator, 26, 46
    - >= greater than or equal to operator, 26, 46
    - >> shift right operator, 23, 46
  - right-associative operators, 45
  - rounding errors, 25
  - runtime overload resolution, 172
  - runtime type checking, 80
  - RuntimeBinderException class, 169
- S**
- sbyte type, 19, 24
  - scope of local variables, 48
  - scope of names in namespaces, 57
  - sealed keyword, 75
  - searching arrays, 32
  - searching strings, 30
  - <see> XML tag, 186

- <seealso> XML tag, 187
- select clause, query
  - expressions, 153
- Select operator, LINQ, 143, 148
- selection statements, 49–52
- SelectMany operator, LINQ, 148
- self-referencing generic
  - declarations, 97
- semicolon (;)
  - terminating statements, 4, 9
- SequenceEqual operator, LINQ, 145, 150
- sequences, LINQ, 141
- serialization, attributes for, 173
- set accessors, 64, 65
- set operators, LINQ, 145, 147, 149
- SetValue method, arrays, 32
- shift left operator (<<), 23, 46
- shift right operator (>>), 23, 46
- short type, 19, 24
- short-circuiting, 27
- signature of method, 60
- Single operator, LINQ, 144, 150
- single quote (')
  - escape sequence for, 28
- SingleOrDefault operator, LINQ, 144, 150
- sizeof keyword, 46
- Skip operator, LINQ, 143, 148
- SkipWhile operator, LINQ, 148
- slash (see forward slash)
- Sort method, arrays, 32
- sorting arrays, 32
- Split method, strings, 31
- square brackets ([])
  - array declaration or index, 31, 45
  - enclosing attributes, 174
  - indexer declaration, 66
- stack, 35, 78
- stackalloc keyword, 45, 180
- StackTrace property, System.Exception, 123
- StartsWith method, strings, 30
- statement block, 4, 9, 48
- statements, 4, 48–55
  - declaration statements, 48
  - expression statements, 48
  - iteration statements, 52–54
  - jump statements, 51, 54–55
  - selection statements, 49–52
- static binding, 165
- static classes, 68
- static constructors, 67
- static members of types, 13
- static type checking, 80
- string type, 11, 29–31
- strings, 28–31
- struct constraint, 96
- structs, 82–83
- subclassing generic types, 97
- Substring method, strings, 31



subtract operator (-), 46  
 Sum operator, LINQ, 150  
 <summary> XML tag, 185  
 switch statement, 51–52  
 System.ArgumentException  
   class, 123  
 System.ArgumentNullException  
   class, 124  
 System.ArgumentOutOfRangeException  
   class, 124  
 System.Exception class, 123  
 System.InvalidOperationException  
   class, 124  
 System.NotImplementedException  
   class, 124  
 System.NotSupportedException  
   class, 124  
 System.ObjectDisposedException  
   class, 124

## T

Take operator, LINQ, 143,  
   148  
 TakeWhile operator, LINQ,  
   148  
 ternary conditional operator  
   (?:), 27, 47  
 ThenBy operator, LINQ, 149  
 ThenByDescending operator,  
   LINQ, 149  
 this keyword (calling another  
   constructor), 61  
 this modifier (for extension  
   methods), 138  
 this reference (referring to  
   instance), 63  
 tilde (~)  
   bitwise complement  
     operator, 23, 46  
   finalizers, 68  
 ToArray operator, LINQ, 146,  
   151  
 ToDictionary operator,  
   LINQ, 146, 151  
 ToList operator, LINQ, 146,  
   151  
 ToLookup operator, LINQ,  
   146, 151  
 ToLower method, strings, 31  
 ToString method, object class,  
   82  
 ToUpper method, strings, 31  
 Trim method, strings, 31  
 TrimEnd method, strings, 31  
 TrimStart method, strings, 31  
 true boolean value, 11  
 try statement, 117–124  
 type parameter variance,  
   delegates, 106  
 typeof operator, 45, 80, 95  
 types, 10–19  
   anonymous types, 140  
   conversions between (see  
     conversions)  
   custom, 11–14  
   generic types, 92  
   getting, 80  
   instantiating, 13  
   members of, 12  
   nested, 91  
   numeric types, 19–25  
   partial types, 68–70  
   predefined (built-in), 10,  
     12, 18  
   primitive types, 19

reference types, 15, 16, 18  
 runtime checking of, 80  
 static checking of, 80  
 value types, 15, 18

## U

U suffix, numeric literals, 20  
 uint type, 19  
 ulong type, 19  
 unary operators, 43  
 unbound generic types, 95  
 unboxing, 79–80, 132  
 unchecked operator, 23, 45  
 #undef directive, 183  
 Unicode characters, escape sequences for, 28  
 Union operator, LINQ, 145, 149  
 unmanaged code, pointers and, 181  
 unsafe code, 177–181  
 unsafe keyword, 178  
 upcasting, 71  
 ushort type, 19, 24  
 using directive (importing namespaces), 5, 57, 59  
 using statement (leveraging IDisposable), 121

## V

value types, 15, 18  
 var keyword, 42  
 variables, 35–43  
   assignment, 36  
   default values, 37  
   iteration variables, capturing, 115  
   local variables, 4, 42

outer variables, capturing, 114

verbatim strings, 29

vertical bar (|)

  bitwise or operator, 23

  logical or operator, 47

  || conditional or operator, 27, 47

vertical tab, escape sequence for, 28

virtual members, 73, 87

void expressions, 43

void return type, 5

void\* pointer, 181

## W

#warning directive, 182, 183

Where operator, LINQ, 142, 148

while loops, 52

whitespace, adding or removing, 31

## X

XML, for documentation comments, 184–187

## Y

yield break statement, 128

yield return statement, 127–128

## Z

zero

  division by, 22

  negative, 24